

PMA Prozess- und Maschinen-Automation GmbH

Operator's Guide

**KS 108 easy
advanced line**

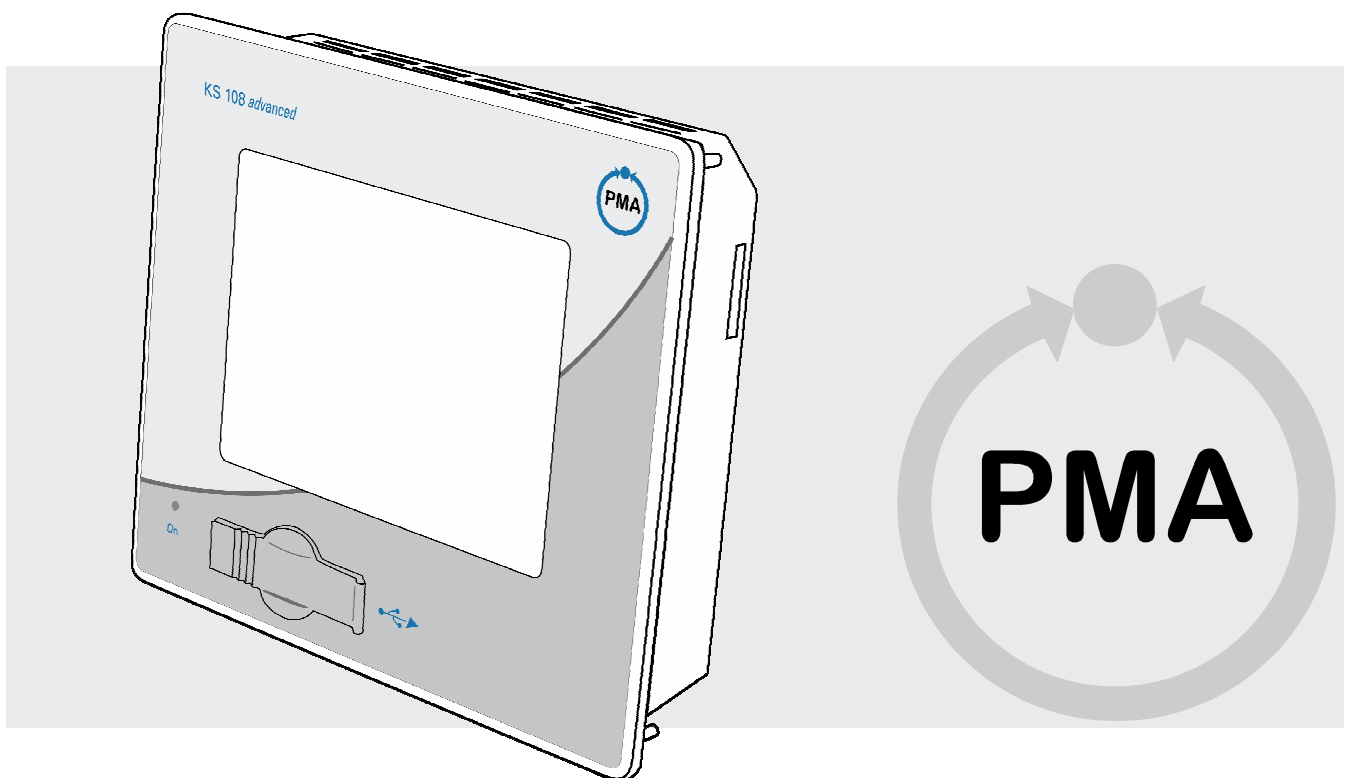

preliminary



Operator's guide, please read before using product

Bestellnummer:
9499-040-85611

© PMA
Prozeß- und Maschinen-Automation GmbH
Miramstraße 87
34123 Kassel

Tel.: + 49 / 0561 / 505-0
Fax.: + 49 / 0561 / 505-1710

mailbox@pma-online.de
www.pma-online.de
Release: 19. Juni 2007
Revision: 0.0

Contents

I	Operator guide	6
I-1	General	6
I-1.1	Information on the operator's guide	6
I-1.2	Manufacturer	6
I-1.3	Guarantee conditions	6
I-1.4	Customer service	6
I-1.5	Explanation of symbols	7
I-1.6	Limitation of liability	8
I-1.7	Copyright	8
I-1.8	Transport, packaging, and storage	9
I-1.8.1	Transport	9
I-1.8.2	Unpacking	9
I-1.8.3	Storage	9
I-1.9	Disposal	9
I-2	Safety	11
I-2.1	General	11
I-2.2	Owner's responsibility	12
I-2.3	Operating personnel	13
I-2.3.1	Requirements	13
I-2.3.2	Instruction	13
I-2.4	Safety integrated systems	13
I-2.5	Special dangers	14
I-2.5.1	Device failure, maintain, decommissioning	14
I-2.5.2	Explosion protection	14
I-2.5.3	Electric components	15
I-2.5.4	Batteries	15
I-2.5.5	Application development	15
I-2.6	Environmental protection	16
I-2.7	Intended use	16
I-3	Structure and function, technical data	17
I-3.1	Device description	17
I-3.2	Models	18
I-3.3	Accessories	19
I-3.4	Performance features - overview	19
I-3.5	Device overview	20
I-3.6	Technical data	20
I-3.7	Type plate	22
I-3.8	Block diagram	23
I-3.9	Interfaces	23
I-3.9.1	Overview	23
I-3.9.2	Power supply	24
I-3.9.3	10/100 Base-T network connection (Ethernet)	24
I-3.9.4	USB	24
I-3.9.5	CAN bus	25
I-3.9.6	Serial interfaces	25

I-3.10	Declaration of conformity.....	26
I-4	Mounting and commissioning	27
I-4.1	Scope of delivery	27
I-4.2	Mounting.....	27
I-4.2.1	Mounting cutout	27
I-4.2.2	Mounting.....	28
I-4.2.3	Connecting the device	29
I-4.3	Commissioning	31
I-4.3.1	Checking the installation	31
I-4.3.2	Switching on the device	31
I-4.3.3	Loading the program from USB stick	32
I-4.3.4	Configure network settings	34
I-4.3.5	Using an SD card	34
I-4.3.6	External I/O connection	35
I-5	Operation.....	36
I-5.1	User operating page	36
I-5.2	Main menu.....	38
I-5.3	Using the menu.....	38
I-5.4	Navigating in the menu.....	39
I-5.5	Changing parameters and configurations	39
I-5.5.1	Using the list selection editor	40
I-5.5.2	Using the numerical value editor	40
I-5.5.3	Using the binary number editor.....	41
I-5.5.4	Using the text editor	41
I-5.6	Using the "General Data" menu.....	42
I-5.6.1	Configure network	44
I-5.7	Operating pages	47
I-5.7.1	Operating page V_ALARM.....	48
I-5.7.2	Operating page V_DISPLAY	51
I-5.7.3	Operating page V_BAR.....	53
I-5.7.4	Operating page V_LOGGING	54
I-5.7.5	Operating page V_TREND	57
I-5.7.6	Operating page CONTROL	62
I-5.7.7	Using controllers in controller cascades.....	66
I-5.7.8	Detailed information on self-optimization	67
I-5.7.9	Operating page A_PROG	79
I-5.7.10	Operating page D_PROG	84
I-6	Maintenance and cleaning	86
I-6.1	Maintenance.....	86
I-6.1.1	Real-time clock	86
I-6.1.1	Changing batteries.....	87
I-6.2	Cleaning.....	89
I-6.2.1	Cleaning heavy fouling	89
I-6.3	After maintenance.....	90
I-7	Troubleshooting.....	91
I-7.1	Fault table	92
II	Index.....	93

I Operator guide

I-1 General

I-1.1 Information on the operator's guide

Compliance with all safety instructions and handling instructions specified in the operator's guide is the prerequisite for safe work and proper handling of the device.

In addition, guidelines, standards, local accident prevention regulations, and safety regulations must be complied with for the implementation area of the device.

The operator's guide is a component of the product and must be kept accessible in the immediate vicinity of the device at all times for installation, operating, maintenance, and cleaning personal.

The graphic illustrations in this guide are used to present the explained subject matter and consequently are not necessarily shown to scale and can deviate slightly from the actual version of the device.

I-1.2 Manufacturer

PMA Prozeß- und Maschinen-Automation GmbH
Miramstr. 87
D-34123 Kassel

Tel. +49 0561 505-1307
Fax +49 0561 505-1710
e-mail: mailbox@pma-online.de



I-1.3 Guarantee conditions

The current guarantee provisions and information concerning the guarantee are in our general terms and conditions, for example on the Internet at (<http://www.pma-online.de/de/pdf/agbs.pdf>).

I-1.4 Customer service

Our customer service organization is available to provide technical information, see chapter "Manufacturer's address".

Moreover our employees are always interested in new information and experiences associated with the applications and which can be of value in improving our products.

I-1.5 Explanation of symbols

Warning instructions

Warning instructions are indicated in this operator guide by symbols. The instructions are introduced by signal words that express the scope of the hazard.

Strictly comply with the instructions and act with prudence to avoid accidents, personal injury and property damage.



DANGER!

...indicates an immediately dangerous situation that can cause death or serious injuries, if not avoided.



WARNING!

...indicates a possible dangerous situation that can cause death or serious injuries, if not avoided.



CAUTION!

...indicates a possible dangerous situation that can cause insignificant or minor injuries, if not avoided.



CAUTION!

...indicates a possible dangerous situation that can cause property damage, if not avoided.



CAUTION!

ESD-sensitive components!

... indicates a situation that can damage or destroy components through electrostatic discharge.

Tips and recommendations



NOTE!

... indicates tips and recommendations as well as information for efficient and malfunction-free operation.

I-1.6 Limitation of liability

All information and instructions in this guide have been compiled under due consideration of applicable standards and guidelines, the current state of the technology, as well as our extensive knowledge gained in years of experience.

Manufacturer accepts no liability for damages due to:

- Failure to heed the instructions in the guide
- Non-intended use
- Deployment of untrained personnel
- Unauthorized conversions
- Technical changes
- The use of non-approved replacement parts

The actual scope of delivery can deviate from the explanations and presentations provided in this guide in the case of special versions, if additional options are ordered, or due to the latest technical changes.

In all other cases the obligations set forth in the supply contract, manufacturer's terms and conditions, as well as the valid legal regulations at the time the contract was concluded, apply.



NOTE!

This operator guide must be read carefully prior to starting any work on and with the device! The manufacturer accepts no liability for damage and malfunctions that arise from failure to heed the instructions in the operator guide.

I-1.7 Copyright

Treat the operator guide with confidentiality. It has been prepared exclusively for personnel working with the device. Supplying the operator guide to third parties without the written approval of the manufacturer is prohibited.



NOTE!

Content information, text, drawings, graphics, and other presentations are protected by copyright, and are subject to intellectual property rights. Any abusive utilization is punishable.

Duplication in any manner - including excerpts - as well as utilization and/or communication of the content are prohibited without manufacturer's written declaration. Offenders are liable for damages. The right to enforce additional claims remains reserved.

I-1.8 Transport, packaging, and storage

I-1.8.1 Transport

Keep the original packaging in order to ship the device in the original packaging if there is a guarantee case. Protect the device from severe mechanical stress in transport. Always transport the device in the original packaging. The installed components are sensitive to impact and strong vibration.

I-1.8.2 Unpacking

Proceed as follows to unpack the device:

- We recommend inspecting the device for transport damage immediately after it is delivered. Only acknowledge receipt with reservation (for example on the freight document), if there is reason to suspect damage. Note the presumed damage on the freight document and inform the manufacturer.
- Carefully remove the packaging.
It is a good idea to keep the packaging. It can be used for later necessary transport of the device, (for example if there is a device defect).
If there is no appropriate agreement concerning take-back of packaging material, then the packaging remains with the customer.



NOTE!

Cardboard and plastics (foil and foam) have been used as packaging material. If the packaging will be disposed of, then environmentally responsible disposal must be ensured in accordance with applicable disposal guidelines.

I-1.8.3 Storage



CAUTION! Condensation of water!

Condensation of water is possible due to temperature fluctuations. This can destroy the device or subsequent malfunctions can result.

Therefore:

- After storage or transport in cold weather, or if there are extreme temperature fluctuations, the device must slowly adjust to the ambient temperature at the implementation site before it is started up.
- If condensation has formed, then the device should only be placed in service after a waiting period of 12 hours.

The following guidelines apply for storage:

- Relative humidity: Max. 85 %
- Ensure that the packages are not stored outside
- Store in a dust-free environment
- Storage temperature -20 to +70 °C
- Avoid mechanical impact and damage

I-1.9 Disposal

If no return or disposal agreements have been made, then the professionally dismantled components must be recycled:

- Scrap metallic material remnants.

- Take plastic elements to plastic recycling facilities.
- Sort the other components for disposal, based on material condition.

**NOTE!**

Electrical scrap, electronic components, lubricants and other auxiliary substances are subject to guidelines for special waste and should only be disposed of by approved specialized companies.

I-2 Safety

This section provides an overview of all important safety aspects for optimal protection of personnel, as well as for safe and malfunction-free operation.

Significant dangers can arise if the handling instructions and safety instructions listed in this guide are not heeded.

I-2.1 General

The device and the associated software have been developed in accordance with the acknowledged rules of standard engineering practice, and they are operationally safe.

This device has been manufactured and tested in accordance with VDE 0411 / EN 61010-1, and it left the plant in perfect safety-related condition.

However this device can cause hazards if it is not used by properly trained personnel, or if it is used improperly, or if it is not used as intended.

- Every person who is assigned to perform work on or with the device must have read and understood the operator guide prior to starting work on the device. This also applies if the person concerned has already worked with such a device or with a similar device, or if he has been trained by the manufacturer.
- Knowledge of the content of the operator guide is one of the prerequisites to protect personnel from hazards, as well as for avoiding errors, and thus is a prerequisite for safe and malfunction-free device operation.
- To avoid danger and to assure optimal performance, neither changes nor conversions should be made to the device unless they have been expressly approved by the manufacturer.
- All safety warning signs and operating warning signs on the device must be maintained in legible condition. Damaged or signs or signs that have become illegible must be replaced immediately.
- The setting values or value ranges that are specified in the operator guide must be complied with.
- The owner is recommended to have personnel verifiably confirm that they have understood the content of the operator guide (see the section "Instruction" in this regard).

I-2.2 Owner's responsibility

The device is implemented commercially. Thus the owner of the device is subject to legal industrial safety obligations.

In addition to the industrial safety instructions in this operator guide, the safety, accident prevention, and environmental protection regulations, applicable at the site of implementation must be complied with. In particular:

- Owner must inform himself of applicable industrial safety regulations and determine additional hazards that arise due to the special work conditions prevailing at the site where the device is implemented, in a risk analysis. The risk analysis must be implemented in the form of work instructions for device operation.
- Owner must check throughout the entire implementation period of the device, whether the work instructions that owner has created satisfy current legislation, and must adapt them if necessary.
- Owner must clearly regulate and specify the responsibilities for installation, operation, maintenance, and cleaning.
- Owner must ensure that all employees who work with the device have read and understood the operator guide.

Moreover owner must train personnel and inform them of dangers at regular intervals.

In addition owner is responsible to ensure that the device is always in a technically perfect condition; therefore the following applies:

- Owner must ensure that the maintenance intervals described in this operator guide are complied with.
- Owner must have all safety devices inspected regularly for function and completeness.
- Owner must provide personnel with the required protective gear.

I-2.3 Operating personnel

I-2.3.1 Requirements



WARNING!

Danger of injury if personnel are not qualified!

Improper handling of the device can cause serious personal injury and property damage.

Therefore:

- Only have those persons who have been designated in the respective chapters of this operator guide perform special activities.
- If in doubt obtain the assistance of specialists.

In the operator's guide the following qualifications are cited for various activity areas:

■ **Instructed person**

has been instructed by owner in a training session concerning the assigned tasks and possible hazards in the event of improper behavior.

■ **Skilled personnel**

are personnel who, due to their specialized training, knowledge, and experience, as well as knowledge of applicable regulations, are capable of executing the tasks assigned to them and of recognizing possible hazards on their own.

■ **Qualified electrician**

is a person who due to his specialized training, knowledge, and experiences, as well as knowledge of applicable standards and regulations, is capable of performing work on electrical equipment, and who can recognize possible hazards on his own.

The certified electrician has been especially trained for the work environment where he is active and knows the relevant standards and regulations.

In Germany the qualified electrician must satisfy the provisions of the accident prevention regulation BGV A3 (for example certified master craftsman for electrical fittings). Similar regulations apply in other countries.

Only persons, from whom can be expected that they reliably perform their work, are approved as personnel.

Persons whose reaction capability is influenced by drugs, alcohol, or medication are not approved.

Comply with the age-specific and job-specific regulations applicable at the implementation site.

I-2.3.2 Instruction

Personnel must be instructed regularly by operator. For better tracking training execution must be logged.

Such a log can look like this:

Date	Name	Type of instruction	Instruction performed by	Signature
04.04.2006	Heinz Lehrling	First safety instruction for XY	Willi Meister	
17.05.2006	Horst Werker	Annual safety instruction 2006 for XY	Willi Meister	
...	

Table 1: Instruction log

I-2.4 Safety integrated systems

Use of the device (as with all other PLC's) in safety integrated systems requires special measures. If safety integrated implementation is planned, then the user must take the applicable standards (e.g. DIN EN 61508) into consideration, and in addition should consult with PMA.

I-2.5 Special dangers

The following section lists the residual risks that arise due to the risk analysis.

Heed the safety instructions listed here, and the warning instructions in subsequent chapters of this guide, to reduce health hazards and dangerous situations.

I-2.5.1 Device failure, maintain, decommissioning



DANGER!

Danger of injury due to unforeseeable system function sequences and movement sequences!

System components can be placed in movement during maintenance work, configuration work, or function checks, if they are not disconnected from the device.

Therefore:

If the device is taken out of service, if new or changed applications are loaded on the device, or if maintenance or a function check is performed, the following must be heeded:

- All system components must be disconnected from the device!
- All switched off system components must be safeguarded from being inadvertently switched on again!
- In general the effects of switching off the system must be taken into consideration and appropriate measures must be taken.



DANGER!

Danger of injury due to uncontrolled/unforeseeable operating sequences!

As with any electronic controller system, device failure can result in an uncontrolled and/or unforeseeable operating sequence. Death, serious injury, or significant property damage can be the result.

Therefore:

- Ensure that appropriate measures are in place every time the device is used.

I-2.5.2 Explosion protection



Warning!

Explosion hazard due to live components!

In hazardous environments live devices can trigger explosions. The device does not have explosion protection.

Therefore:

- The device should not be used in hazardous atmospheres.

I-2.5.3 Electric components

**CAUTION!****Electrical hazard for components!**

Device components can be damaged or destroyed by electric voltages.

Consequently when working inside the device ensure the following:

- Disconnect the device from the power supply.
- Ensure that no objects or tools fall into the device.

I-2.5.4 Batteries

**WARNING!****Danger of injury if batteries are handled improperly!**

Batteries must be handled with particular care.

Therefore:

- Do not throw batteries into a fire or expose them to high temperatures. There is an explosion hazard.
- Do not charge batteries. There is an explosion hazard.
- Liquid that escapes from batteries, if they are used improperly, can cause skin irritations. Avoid contact with the liquid. If there is contact with the liquid rinse thoroughly. If the liquid gets into the eyes immediately rinse with water for 10 minutes and seek medical attention without delay.

I-2.5.5 Application development

**WARNING!!****Danger of injury or danger of property damage through unforeseeable program sequence!**

As with any electronic controller system, software errors can result in an uncontrolled and/or unforeseeable operating sequence. Death, serious injury, or significant property damage can be the result.

Therefore:

- Ensure that the system is only used after an extensive test (see EN 61131 in this regard).
- Virtually all function blocks should only be called once during a sampling step. If they are called multiple times then a new instance of the function block will not be created, rather there is only an additional reference to an existing function block (the existing instance). Under behavior is the result.

I-2.6 Environmental protection



CAUTION!

Incorrect handling causes environmental hazards!

Incorrect handling of environmentally harmful substances, particularly improper disposal, can cause significant damage for the environment.

Therefore:

- Always comply with the instructions listed below.
- Initiate suitable measures immediately if environmentally harmful substances inadvertently get into the environment. If in doubt inform the responsible municipal authorities about the damage

I-2.7 Intended use

The operational safety of the device is only ensured if the device is used as intended in accordance with the instructions in the operator's guide.

- The device is designed for use as a multi-function controller or for controlling and/or regulating machines and industrial processes. It should only be used within overvoltage category I (IEC 364-4-443), in low voltage systems where the rated supply voltage does not exceed 1000 V AC voltage (50/60 Hz), or 1500 V DC.
- Intended use includes correct compliance with the mounting, operating, maintenance, and cleaning instructions.
- Any use extending beyond intended use, or any other type of device utilization is prohibited and is considered as non-intended use! Claims of any type against the manufacturer and/or manufacturer's authorized agents for damages due to non-intended use of the device are excluded. The owner is solely liable for all damages due to non-intended use.

I-3 Structure and function, technical data

I-3.1 Device description

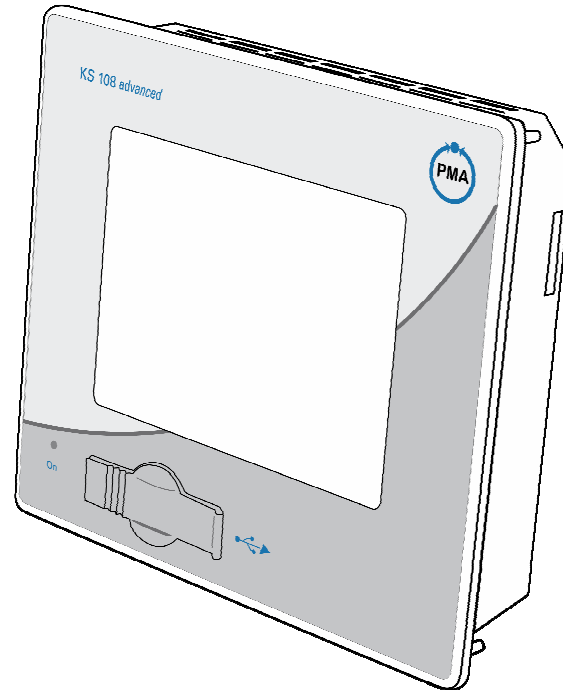

Fig. 1: Device description

The KS 108 is a control module with real-time capability with a touch-sensitive screen (touchscreen) and a broad spectrum of data interfaces. The device is programmed in accordance with the IEC 61131-3 standard with the BlueDesign development environment.

The KS 108 is designed for front panel mounting or control cabinet mounting in rough industrial environments. Maintenance requirements are minimal due to the fan-less design and flash memory.

I-3.2 Models

The device is available in the following models (future modules are indicated by gray font).

Automation unit KS 108	K S 1 0 8 - x x x - x x x x x - x xx									
BASIC UNIT	↑	↑	↑	↑	↑	↑	↑	↑	↑	↑
KS 108 easy	1									
KS 108 flexible	2									
KS 108 PLC	3									
DISPLAY										
5.7" CSTN, QVGA (320 x 240)	0									
5.7" TFT, QVGA (320 x 240)	3									
Not assigned	0									
FIELDBUS OPTION ¹⁾										
On request				0						
Additional interfaces (on request)				0						
INSTALLED I/O										
None				0						
ADDITIONAL INTERFACES ²⁾										
On request					0					
PMA FUNCTION LIBRARY										
only KS 108 Flexible					0					
DEFAULT SETTING										
Standard setting							0			
Setting according to specification							9			
APPROVALS										
CE									0	
CE, UL/cUL certified (applied for)									U	
FRONT MEMBRANE										
PMA standard										00
Customer-specific front membrane (from 100 ST)										xx

1) Communication protocol is configurable: (e.g. **MODBUS/TCP**, Ethernet/IP, ProfiNet, CANopen, DeviceNet, etc.)

2) Interfaces included in the basic unit: 1 x CAN (galv. separated), 1 x RS485 (galv. separated), 1 x RS232, 1 x Ethernet (galv. separated), 1 x USB (front), 1 x SD card. Additional interfaces could be: second CAN bus, etc.

I-3.3 Accessories

The following accessories can be ordered:

Accessories	KS 108 easy	KS 108 Flexible	KS 108 PLC
BlueDeign (software development environment)	x	-	-
CoDeSys (software development environment)	-	x	x
Ethernet switch (3 to 5x, for top-hat rail)	x	x	x
Engineering manual	x	x	x
Remote I/O components	x	x	x

I-3.4 Performance features - overview

- Freescale POWERPC™ CPU / 266 MHz
- 5.7" TFT display, with touchscreen, 320 X 240 pixels or
5.7" CSTN display, with touchscreen, 320 X 240 pixels
- User program memory and data memory (RAM): 64 MB / 32 MB for application
- User program memory (flash): 16 MB / 8 MB for application
- Retain memory 16 KB
- 1 Ethernet 10/100 interface
- 1 USB host interface
- 1 CAN interface
- 1 serial interface - RS 232 for programming tools
- 1 serial interface - RS 485
- Real-time clock
- MMC-/SD card slot
- optional:
 - Three extension slots for I/Os
 - One communication module (Profibus)
 - Second CAN interface
 - Second serial interface

I-3.5 Device overview

- 1 Display (touch sensitive)
- 2 Mode display
- 3 Cover USB interface
- 4 MMC-/SD card slot
- 5 Stud bolts

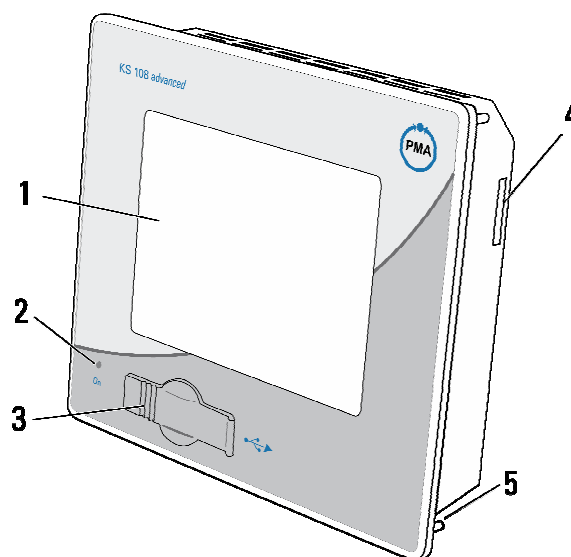

Fig. 2: Device overview (front)

I-3.6 Technical data

Feature	Value	
Display		
Type	CSTN, color	TFT, color
Service life CCFL (backlit display)	40,000 h	60 000 h
Diagonal	5,7"	
Resolution	320 x 240 pixels (1/4 VGA)	
Colors	256 (8-bit per pixel)	
Touchscreen	resistive	
CPU, application memory		
CPU	Freescale PowerPC 266 Mhz	
Program memory (flash)	16 MB / 8 MB for applications	
Program memory and data memory (RAM)	64 MB / 32 MB for applications	
Retain memory	16 KB	
Real-time clock	Yes, battery buffered (SONY CR1620)	
Size and weight		
Dimensions (W x H x T)	194 mm x 172 mm x 50 mm (incl. Front panel) Mounting depth 70.0 mm	
Weight	Approx. 1.5 kg	

Feature	Value
Operating conditions	
Ambient temperature	0° C to 50° C
Relative humidity	Max. 85% non-condensing
Resistance to vibration	
Vibration	Sinusoidal (EN 60068-2-6) Test: Fc 10 ... 150 Hz, 1 G
Shock resistance	15 G (approximately 150 m/s ²), 10 ms duration, half sine (EN 60068-2-27) test: Ea
EMC, protection class	
Noise radiation	EN 61000-6-4, EN 61326-1, industrial
Interference immunity	EN 61000-6-2, EN 61326-1, industrial
General	
Safety	EN 61010-1 (VDE 0411-1), EN 61131-2: Overvoltage category: II Contamination level: 2 Protection class: III (safety extra-low voltage)
Dielectric strength	EN 61131-2, DC 500 V test voltage
Protection class	Front IP 65, rear IP 20
CE marking	Satisfies the EMC and low voltage directive
Energy supply (24 V power pack unit)	
Supply voltage	+24 V DC (18 V ... 32 V) SELV Maximum residual ripple 4 V _{ss}
Power consumption	typ. 1.0 A, max. 2.0 A at +24 VDC Fusing depending on load of the possibly present I/O max. 12A
Reverse polarity protection	Yes
Galvanic isolation	Yes
Ethernet interface	
Number/ type of interface	1 x 10/100 Base T
Connection	RJ45
Potential isolation	Yes
USB interface	
Number/ type of interface	1 x host USB 1.1, ()
CAN bus interface	
Number/ type of interface	1 x standard CAN ISO 11898
Galvanic isolation	Yes
Transmission rate	Max. 1Mbit/s
Terminating resistor	Reversible

Feature	Value
Serial interface	
Number/ type of interfaces	1 x RS232 1 x RS485
Galvanic isolation	For RS 485
Terminating resistor	Reversible for RS485
SD card slot	
SD cards recommended	256 MB (Kingston/SanDisk Extreme) 512 MB (Kingston)
Software	
Operating system	LINUX
Runtime system	CoDeSys ¹ or BlueDesign ²
Development environment	CoDeSys ¹ or BlueDesign ²

1) KS 108 flexible and plc

2) KS 108 easy

I-3.7 Type plate

- 1 Product line
- 2 Model / order no.
- 3 Identification number
- 4 Hardware version
- 5 Supply voltage
- 6 Serial number: ID no.: 00041, date: 0626
- 7 Barcode
- 8 CE marking
- 9 Production data: Year: 06, CW: 26
- 10 Corporate logo



Fig. 3: Type plate KS 108 flexible

I-3.8 Block diagram

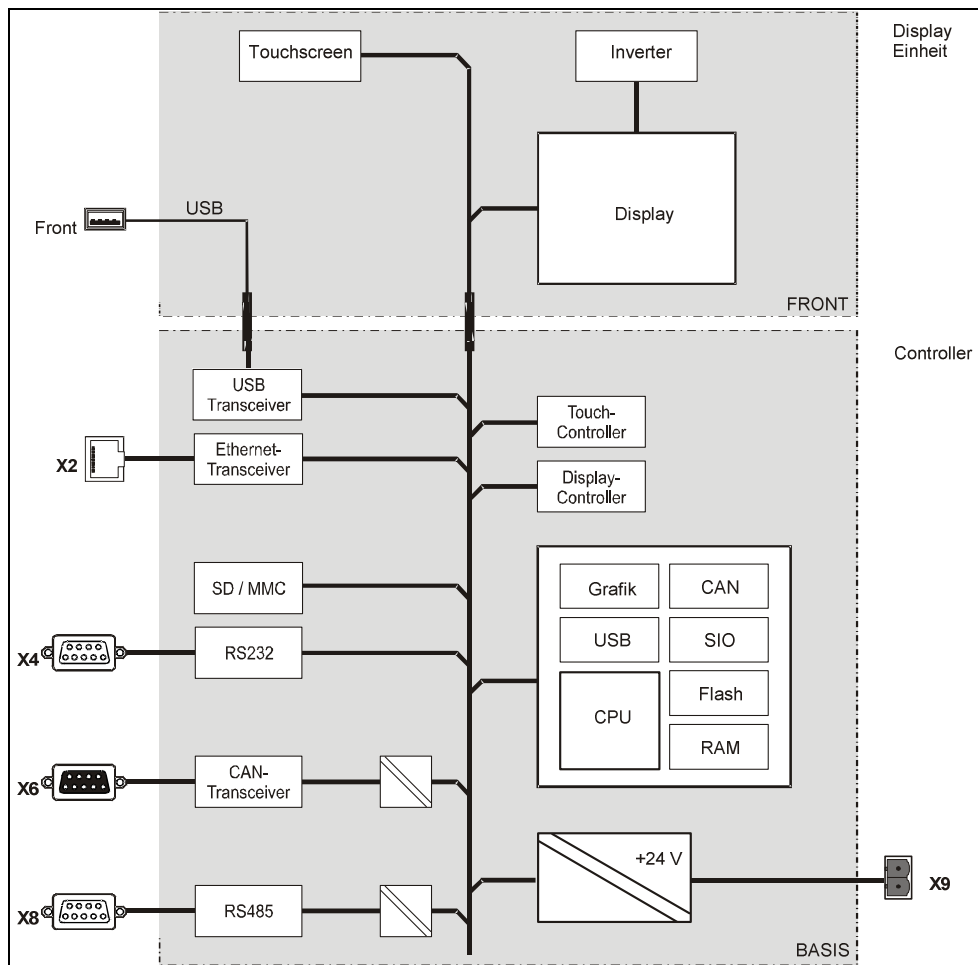

Fig. 4: Block diagram

I-3.9 Interfaces

I-3.9.1 Overview

- 1 Status LED - supply voltage
- 2 Mode selector switch
- 3 Status LED - program status
- 4 Network connection (Ethernet)
- 5 Serial interface (RS 232)
- 6 Switch - CAN BUS terminating resistor
- 7 CAN interface
- 8 Switch - serial interface terminating resistor
- 9 Serial interface (RS 485)
- 10 Network connection

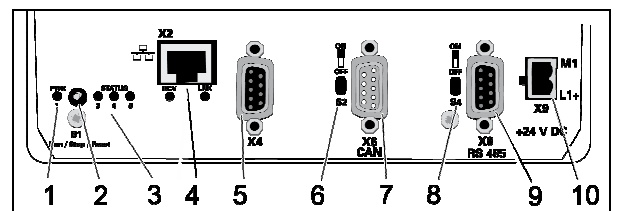

Fig. 5: Interface overview

I-3.9.2 Power supply

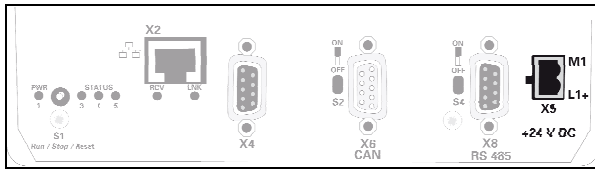

Fig. 6: Power supply

The device will provide with 24 V DC (18 V to 32 V). In addition it has integrated reverse polarity protection and inrush current limitation.

Pinning:

Overview	Feature	Description
	L1+	External power supply 24 V DC (18 V ... (32 V).
	M1	External power supply GND

I-3.9.3 10/100 Base-T network connection (Ethernet)

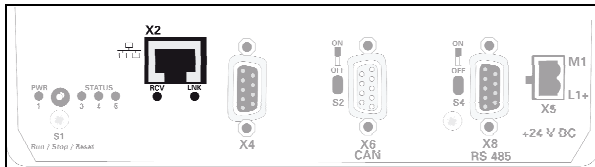
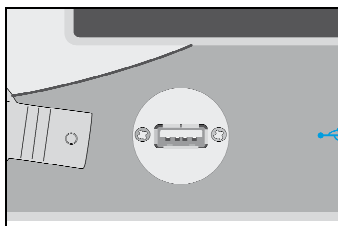

Fig. 7: Ethernet interface (RJ45)

Pinning:

Overview	Feature	Description
	1	TX+
	2	TX-
	3	RX+
	4	75 Ohm
	5	75 Ohm
	6	RX-
	7	75 Ohm
	8	75 Ohm
Connection		RJ-45
LED "LNK"	Green	ON – ready for operation
LED "RCV"	Green	FLASHING - data receive

I-3.9.4 USB



Pinning:

Feature	Description
B1	VCC
B2	D-
B3	D+
B4	GND

Fig. 8: USB interface

The USB connection is on the front of the device.



CAUTION!

Damage to USB devices is possible!

A max. amperage of 0.5 A is available on the USB port. Devices that require more current will not function under some circumstances and can be damaged.

Therefore:

- Only use devices that do not require more than 0.5 A.

I-3.9.5 CAN bus

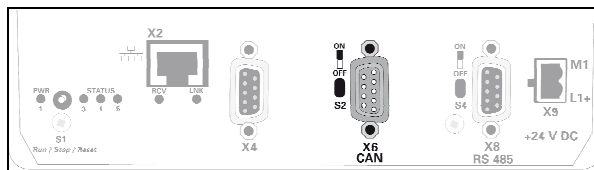

Fig. 9: CAN interface

The CAN interface corresponds to the ISO 11898 standard and can be operated to a maximum baud rate of 1Mbit/s. The interface has an additional isolating element.



NOTE!

A terminating resistor must be located at the beginning and end of a CAN bus topology. Therefore: If the device is at the beginning or end of the CAN bus topology then the terminating resistor must be activated with switch (Fig. 9/6) for the CAN bus. To do this move the switch up to the "ON" position.

Pinning:

PIN	Description
1	NC (do not connect)
2	CAN_L
3	CAN_GND
4	NC (do not connect)
7	CAN_H

I-3.9.6 Serial interfaces

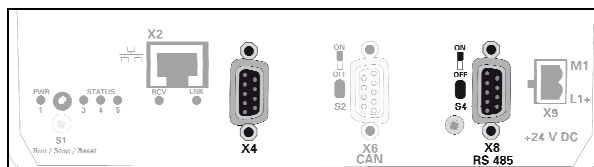

Fig. 10: Serial interface

The device has two serial interfaces:

- RS 232 [X4 / X5: COM1 / COM2] (Fig. 10/5)
- RS 485 [X8 : COM3] (Fig. 10/9): This interface is optically isolated.

RS232 pin assignment:

PIN	Description
1	NC (do not connect)
2	RXD
3	TXD
4	NC (do not connect)
5	GND
6 -9	NC (do not connect)

RS485 pin assignment:

PIN	Description
1	RTXD-
2-3	NC (do not connect)
4	RTXD+
5	GND
6 -9	NC (do not connect)

I-3.10 Declaration of conformity**NOTE!**

Currently the KS 108 is still in the verification process. A CE marking is sought for device operation in industrial as well as in residential applications.

The KS 108 is oriented to DIN 61131, conformity is sought but currently is not present.

I-4 Mounting and commissioning



DANGER!

Danger due to improper installation and commissioning!

Installation and commissioning require trained, specialized personnel with adequate experience. Installation errors can result in life threatening situations or cause significant property damage.

Therefore:

- Only have installation and commissioning performed exclusively by expert employees.
- An installation test must always be performed before startup.
- All switched off plant components must be safeguarded from being inadvertently activated!

I-4.1 Scope of delivery

Before mounting check the scope of supply for completeness:

- Device
- Connecting plug for power supply
- Operator's guide

I-4.2 Mounting

I-4.2.1 Mounting cutout

The device is designed for front mounting.



NOTE!

The material thickness of the bearing material should not exceed 6 mm. Otherwise the device cannot be (reliably) fastened with the stud bolts.

The mounting cutout must have the following format (all specifications are in mm):

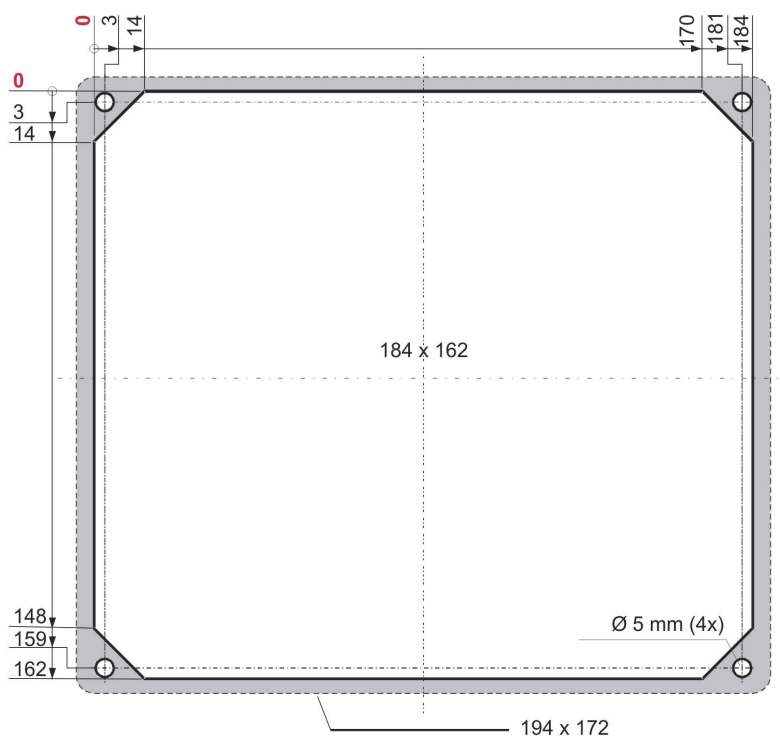

Fig. 11: Mounting cutout

- The device is fastened with four stud bolts (Fig. 11). Four bores with a diameter of 5 mm are provided for the stud bolts.
- The front frame (shown in the illustration above in gray) has dimensions of 194 x 172 mm, thus it will have an overhang relative to the mounting cutout.

I-4.2.2 Mounting



NOTE!

When mounting ensure that

- There is at least 20 mm clearance to the nearest device, or to the nearest wall.
- There is at least 50 mm clearance between the rear of the device and the wall for power and interface cables. The entire mounting depth is 100 mm.

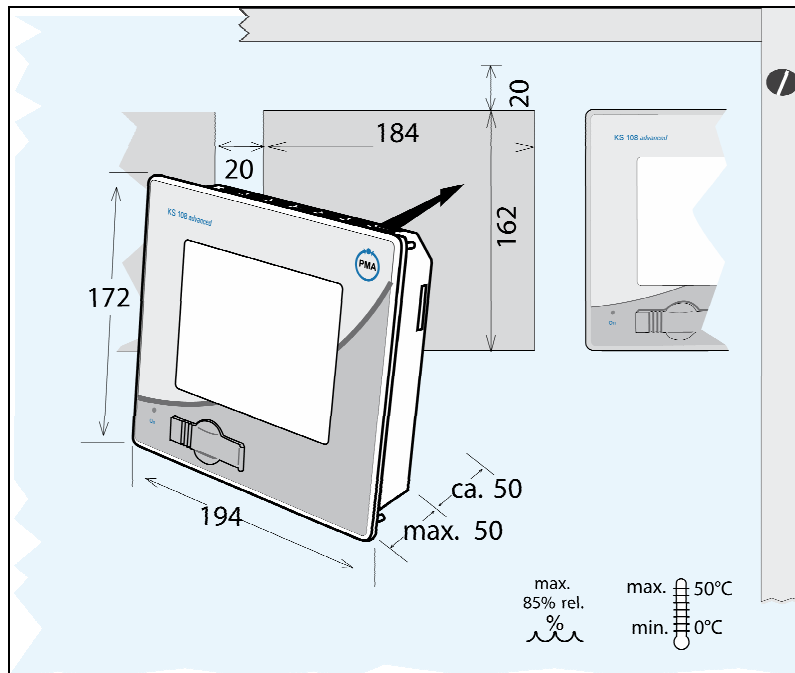

Fig. 12: Mounting

Mount the device as follows:

1. **Remove the fastening nuts and washers:** Remove the fastening nuts and washers from the four stud bolts.
2. **Slide the device into the mounting cutout:** Carefully slide the device into the mounting cutout from the front.
3. **Fix the device in place:** Fasten the device in the mounting cutout. Place a washer on each of the stud bolts. Now mount the nuts on the stud bolts and carefully tighten them.

I-4.2.3 Connecting the device



DANGER!

Injury hazard due to unforeseeable system function sequences and movement sequences

System parts can be placed in motion when mounting, if they are not appropriately secured.

Therefore:

If the device is mounted the following must be heeded:

- All system parts that are switched off must be safeguarded from being switched on inadvertently!
- In general, the effects of switching off the system must be considered, and appropriate measures must be taken.

Connecting the PE

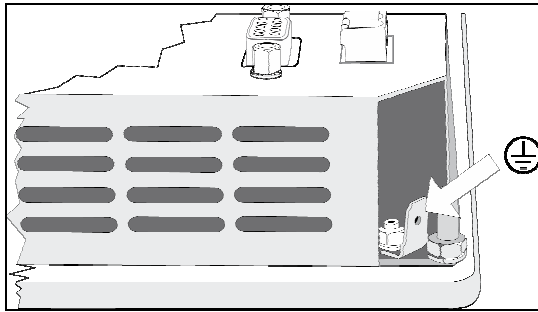

Fig. 13: PE

1. **Connect PE:** Connect the tab of the PE connection (see Fig. 13) to the protective earth. To do this use a line with a core cross-section of at least Cu 1.5 mm².

Connecting the power supply

The KS 108 requires an external power supply with the following specifications:

External power supply specifications for the KS 108	
Output voltage	+24 VDC SELV (18 ... 32 VDC)
Residual ripple	Max. 4 V _{ss} The DC voltage level should not exceed 18 V
Power output	Max. 2.0 A at +24 V DC at 25 °C



CAUTION!

Danger of damaging the device!

Connecting to the wrong power supply can damage the device.

Therefore:

- Ensure that the specifications for the power supply are complied with.
- All cables and connections must be executed in such a manner that malfunctions cannot be caused by inductive and capacitive interference.
- The feed lines must have sufficient current-carrying capacity and withstand voltage.
- Ensure that polarity of the power supply is not reversed.

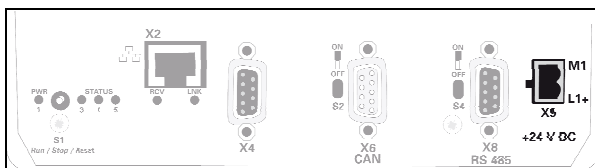

Fig. 14: Power supply

1. **Connecting the power supply:** Connect the power line using the supplied connector with the X9 interface (see Fig. 14/10).

Connecting the interfaces



CAUTION!

Danger of malfunction or damage to the device!

Incorrect configuration/use of the interfaces can result in malfunctions or damage to devices!

Therefore:

- Comply with the instructions concerning the interfaces provided in the chapter "Interfaces"!
- For USB devices: Ensure that only those types of USB devices are used that require a current of no more than 0.5 A.
- For CAN bus topologies: Ensure that a terminating resistor is installed at the end of a CAN bus topology.

1. **Connect the interfaces:** You can connect the interfaces (Ethernet, CAN, etc.) with off-the-shelf cable, ensure that there is adequate shielding and grounding.

I-4.3 Commissioning



DANGER!

Danger of injury if operating personnel are not qualified to work on the device!

Improper handling of the device can cause serious personal injury and property damage.

Therefore:

- The device should only be placed in service by specialized personnel.
Specialized personnel are considered to be persons who have adequate knowledge of the device, the automated processes, and the equipment.

I-4.3.1 Checking the installation

The installation must be checked before the device is placed in service. This is done based on an installation log that must be created for the respective application case.

Here all installation tasks must be checked, however at least the following:

- Protective grounding
- Fuses for the power supply cable and for the master switch
- Agreement of device specification and PLC programming with the actual operating conditions.
- Agreement of the application with local and national guidelines

I-4.3.2 Switching on the device

Proceed as follows to switch on the device.

1. **Switch on:** Switch on the device using the power switch.
After switching on the start screen will be displayed after a short while.
Then you will either see the service menu or you will see the application that will be executed.



NOTE!

Additional information on the operating status is provided in the following section.

**DANGER!****Danger of injury due to unforeseeable plant function sequences and movement sequences!**

If the device is used with other devices/equipment then consequential actions can be induced on these devices/actuators, etc. by switching on the device.

Therefore:

- Prior to switching on the device at any time consider the effects of switching on the device and ensure that appropriate measures have been taken!

**DANGER!****Danger of injury due to an incorrect or defective program!**

The device is freely programmable. Signal processing and signal output, and thus the behavior of connected devices/equipment are determined by the loaded program

Therefore:

- Prior to starting up the device it is strictly necessary to ensure that the correct program is loaded.
- Only place programs in service if their error-free status has been ensured.

I-4.3.3 Loading the program from USB stick

**DANGER!****Danger of injury due to unforeseeable system function sequences and movement sequences!**

System components can be placed in movement during maintenance work, configuration work, or function checks, if they are not disconnected from the device.

Therefore:

If the device is taken out of service, if new or changed applications are loaded on the device, or if maintenance or a function check is performed, the following must be heeded:

- All system components must be disconnected from the device!
- All switched off system components must be safeguarded from being inadvertently switched on again!
- In general the effects of switching off the system must be taken into consideration and appropriate measures must be taken.

New application programs (firmware updates) can be transferred to the KS 108 via USB stick. To do this, proceed as follows:

1. **Copy to USB stick:** Normally you will receive updates via e-mail. Save the attachment to the USB stick. Ensure in this process that a directory with the name "autoinst" has been created on the topmost directory level. Ensure that the files "update.tgz" and "autoinst.ini" are located in this directory.

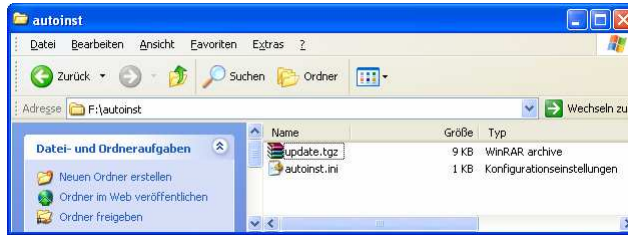

Fig. 15: Update to USB stick

**NOTE!**

An update can only be executed if the USB stick contains the directory structure and files described above!

2. **Switch off the KS 108:** Switch off the KS 108 using the power switch.
3. **Insert the USB stick:** Carefully lift the cover of the USB connection (Fig. 16/1) on the front of the device and turn it to the side. Now insert the USB stick (Fig. 16/2) in the connection (Fig. 16/3).

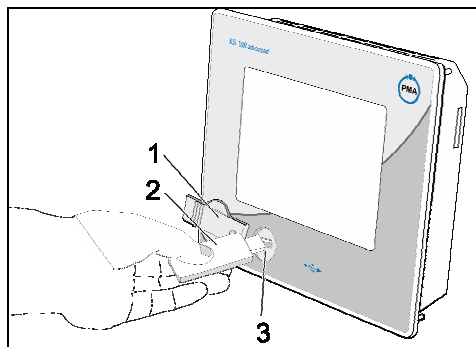

Fig. 16: Using the USB stick

4. **Switch on the device:** Now switch on the device again, The update starts automatically. First you will see the PMA logo and then a terminal window with status messages about the update. After the update the message "USB stick can be unplugged" will be displayed. The device will now restart automatically.

**NOTE!**

The update is executed based on a script. Depending on script execution the messages can be different. It is also possible that a different message will be displayed when the update is concluded.

5. **Remove the USB stick:** Remove the USB stick.

**NOTE!**

If the device does not restart automatically after the update, then it must be restarted manually. To do this switch the device off using the power switch and then switch it on again.

**DANGER!****Danger of injury due to unforeseeable plant function sequences and movement sequences!**

If the device is used with other devices/equipment then consequential actions can be induced on these devices/actuators, etc. by switching on the device.

Therefore:

- Prior to switching on the device at any time consider the effects of switching on the device and ensure that appropriate measures have been taken!

I-4.3.4 Configure network settings

Prior to commissioning you must configure the network settings of the device.

**NOTE!**

Additional information on configuring the network settings is available in the chapter "Menu - using 'General Data'".

I-4.3.5 Using an SD card

Applications for data logger, error memory or historic alarms require an SD card to store their data.

Proceed as follows to install the SD card:

**CAUTION!****Danger of data loss!**

Removing the SD card while the device is in operation can cause data loss. The file structure of the SD card, as well as device data structure can be damaged.

Therefore:

- Always switch the device off first, and then remove the card!

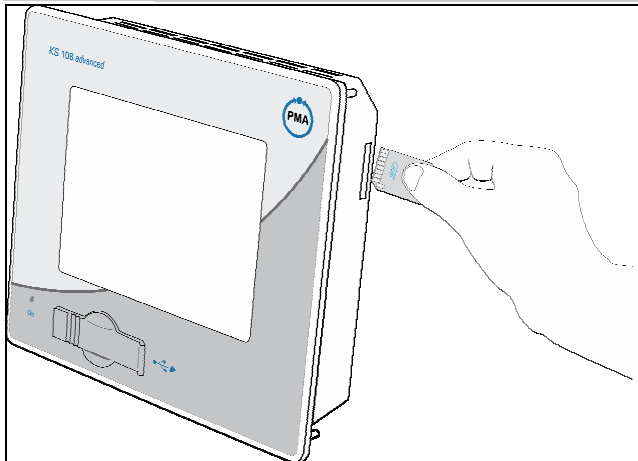

Fig. 17: Using the SD card

Insert card

1. **Switch off device:** Switch off the device.
2. **Insert card:** Carefully insert the SD card into the card slot. When inserting ensure that the beveled side is facing down and that the contacts are pointing to the front.

Removing the card

1. **Switch off device:** Switch off the device.
2. **Remove card:** First push the card that you want to remove carefully into the device until the card is unlocked. Now let go of the card. If the card has been unlocked it will be pushed several millimeters out

of the card slot.
You may now remove the card.

I-4.3.6 External I/O connection

The device offers a CANopen conformant interface and an Ethernet interface for connecting IO systems, sensors, and actuators.



NOTE!

The configuration of the external peripherals differs depending on the device used. The description is in the engineering manual.

I-5 Operation

The *KS 108 easy* is a powerful and flexible multi-functional unit. The device is adapted to the respective application via the *BlueDesign* development environment.

Structure and number of user pages depend exclusively on the programming - in other words they depend on the application. However normally most control elements of the applications are made available through predefined operating pages of the PMA library (e.g. the operating pages for controllers or program generators).

Below you will learn how you can work with these predefined operating pages. In this regard you should note the following: The precise structure of the operating pages depends on the respective application, thus for you the number and type of operating pages, parameters, etc. will be different.

Information on the following topics is provided in this chapter:

- Menu
 - Using the menu
 - Changing parameters and configurations
 - Using the "General Data" menu
- Operating pages
 - Operating pages overview
 - Bargraph "V_BAR"
 - Datalogger "V_LOGGING"
 - Trend "V_TREND"
 - Controllers
 - Digital program generator "D_PROG"
 - Analog program generator "D_PROG"
 - Alarm page "V_ALARM"
 - User display "V_DISPLAY"



DANGER!

Danger of injury or danger of property damage due to a defective program sequence!

Depending on the application numerous configurations or parameters can be changed via operating pages, or direct intervention in regulating or controlling processes are possible. Faulty intervention in applications can result in an uncontrolled and/or unforeseeable operating sequence (as with any electronic controller system). Death, serious injury, or significant property damage can be the result.

Therefore:

- Prior to any action consider the effects of the action and ensure that appropriate measures have been taken.

I-5.1 User operating page

The user operating page is the start page from which the user can branch to other operating pages. The page is application-specific and thus must be completely designed by application developers. The user operating page can include graphics (for instance an overview graphic of the process).

An example of a simple user operating page is provided in the chapter, "A practical example"; for (simplified) control of a three-chamber oven the following control elements are provided here:

- 1 Display of the process value (PV) for each of the three oven chambers
- 2 Symbolic presentation of the control process
- 3 Display of the setpoint (SP) for each of the three oven chambers
- 4 Button: Call main menu
- 5 Button: Call operating pages for controller

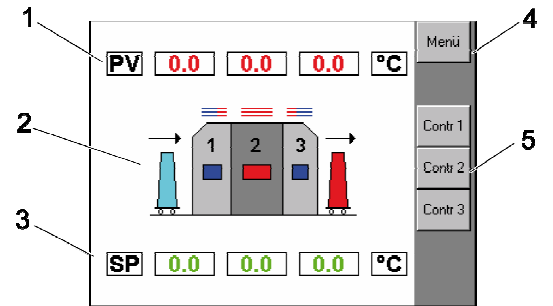

Fig. 18: Example project - three-chamber oven, main operating page

I-5.2 Main menu

Application programs that are created using the PMA library normally have a main menu with the following structure:

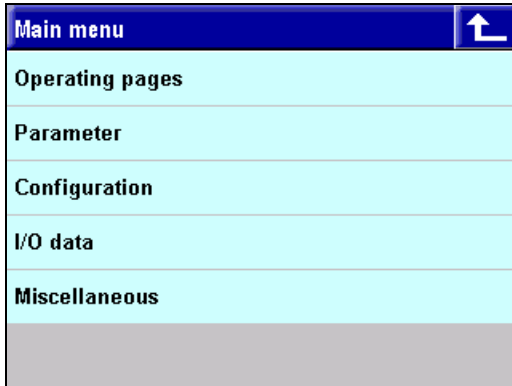

Fig. 19: Main menu

- **Operating Pages:** Calls the PMA library operating pages
- **Parameters:** Calls the PMA library parameter pages.
- **Configuration:** Calls the PMA library configuration pages
- **I/O data:** Calls the I/O pages from the PMA library.
- **General Data:** Calls the general device settings (this menu option is deactivated as default)

I-5.3 Using the menu

With the exception of the menu command *General Data* all menu commands first call a list of function blocks for which the respective option (for instance operating pages) is available.

Consequently proceed as follows to select a page (example: You would like to select the I/O data of a function block):

1. **Call the main menu:** Call the main menu. How this occurs depends on the application program.

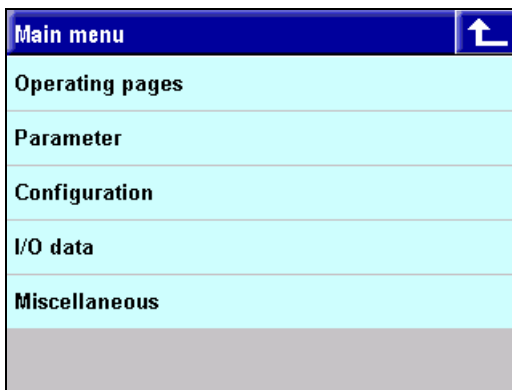

Fig. 20: Example using the menu (main menu)

2. **Call menu *I/O data*:** In the main menu call the submenu *I/O data*.

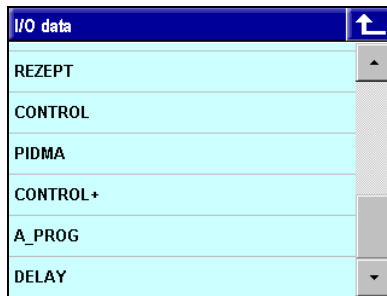

Fig. 21: Example using the menu (I/O data)

- Select function block:** Select the function block for which you want to see the I/O data (in the example: *Delay*).

Now you see the I/O display of the selected function block.

DELAY - I/O data	
ai_X_1	0
ai_Preset	0
di_reset	FALSE
di_preset	FALSE
ao_Y_1	0

Fig. 22: Example of menu use (display I/O data)

- Return to main menu:** Tap on the "Back" button (⏪) to return to the higher level menu.

I-5.4 Navigating in the menu

With the exception of the main menu you will find buttons and a scroll bar on the right side of the screen. Use these buttons to navigate in the menu or to return to the higher level menu.

The page is structured as follows:

- Back:** Return to the higher level menu.
- Up:** Browse one entry up.
- Browse:** Browse down or up.
- Slider:** Slide the controller to browse up or down.
- Down:** Browse down.

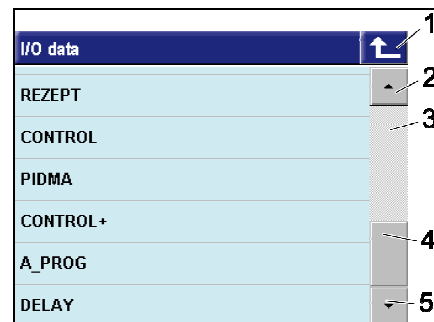

Fig. 23: Using the menu (navigation)

I-5.5 Changing parameters and configurations

You can easily change parameters and configurations via the menu.

To do this, proceed as follows:

- Select submenu:** In the main menu select either the submenu *Parameters* or *Configuration*.
- Select function block:** Now select the function block for which you want to change parameters or the configuration.
- Select value:** Click on the value you want to change (for example "pi_p behavior").

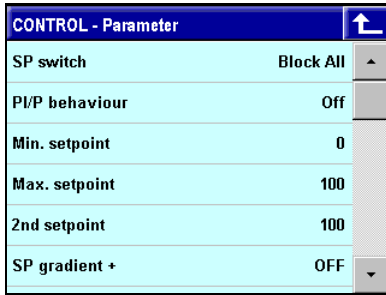

Fig. 24: Changing parameters/configuration

Depending on the selected value you will now see either a list selection field or an editor for entering numerical values.

Under some circumstance entries will be displayed in gray in the selection list. These are entries that are generally possible as an option but have been blocked as part of the current application.

I-5.5.1 Using the list selection editor

Many parameters are input via selection lists. For example the parameter "pi_p behavior" is specified via the following selection list:



Fig. 25: List selection editor

- **Making the selection:** Click on the desired value in the selection list to select it. The selected value will be transferred and the selection list will close.
- **Leaving the list without making a selection:** Click on the "⬆" button to leave the list without making a selection.

Structure of the selection list

Each list entry is comprised of a numerical index value (for instance "0") and a descriptive text (such as, "Switch off"). Background: Non-numeric parameters are managed numerically in the PMA library via index values that represent the desired parameter.

I-5.5.2 Using the numerical value editor

Numerical values (temperature specifications, times, etc.) are entered via a numerical value editor. The current value is displayed in the title line of the numerical value editor (in this case "Grw+ = OFF").

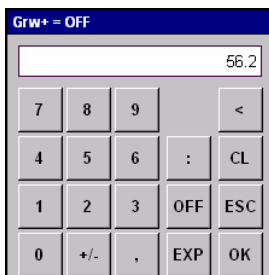

Fig. 26: Numerical value editor

Button	Use
0 - 9	Entering numerical values.
+/-	Change leading signs.

.	Enter decimal or comma.
:	Enter colon. Colons are necessary for time specifications for example.
OFF	Select switch-off value. "OFF" appears in the display. This value can only be selected if it is possible in principle for the current setting.
EXP	Select exponents. Tap on the "Exponent" button, and then enter the exponents. An "e" will appear in front of the entry.
<	Delete last character "Backspace" key).
CL	Delete entire entry.
ESC	Leaving the text editor without updating the entry.
OK	Accept input and leave the editor.

The possibility of using the buttons is context dependent. Thus the colon can only be used for time specifications, e.g. it is deactivated for numerical specifications.



NOTE!

If an invalid value is entered in the numerical value editor then it will be corrected without further feedback when the entry is accepted (when you click on the "OK" button)! In this case the nearest valid (limit) value will be used.

I-5.5.3 Using the binary number editor

Binary numbers (e.g. forced values for the digital program generator) are entered with an editor.

Binary numbers are changed by bit. Consequently tap on the respective bit (or field) to change a value from 0 to 1 (or vice versa).

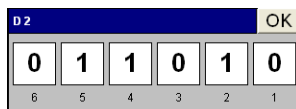

Fig. 27: Numerical value editor

I-5.5.4 Using the text editor

Text (file names, comments, etc.) are entered via a text editor. As is the case with the numerical value editor, the characters that will be entered are entered via buttons.



Fig. 28: Text editor

Button	Use
1 .. m	Alphanumeric value input
Shift	Shift upper case/lower case
BS	Delete last character.

ESC	Leaving the text editor without updating the entry.
OK	Accept input and leave the editor.

i *NOTE!*
 The maximum length of a text field is limited and is usually 16 characters. If an entry is longer than the prescribed length, the text will be corrected without further feedback when the entry is accepted (when you click on the "OK" button)!

I-5.6 Using the "General Data" menu

In the "General Data" menu you can make fundamental system settings. For example you can set the date, the time, or the IP address.

i *NOTE!*
 The structure of the "General Data" menu and the possibility to activate the menu depend on the application development. You can only access the "General Data" menu or access the sub-menu commands, if these possibilities have been provided by the application technician.

The following submenu commands are available as maximum:

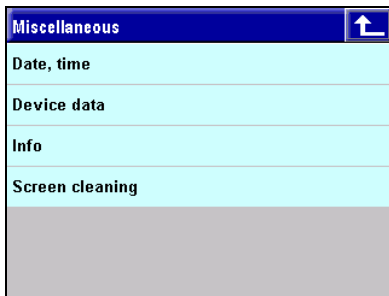

Fig. 29: Menu "General Data"

- **Date, Time** Set the system time
- **Device Data:** Select the language used by the PMA library. German and English can be selected.
- **Info:** Information on the software release version. This information can be useful when requesting service.
- **Clean screen:** An empty screen is displayed so that commands are not executed when the screen is being cleaned.

Date, Time

Set the system date in the *Date, Time* menu.



Fig. 30: Menu "Date, Time"

- Tap on a menu option to change a setting. Use the numerical value editor or the list selection editor (for month) to make the selection.

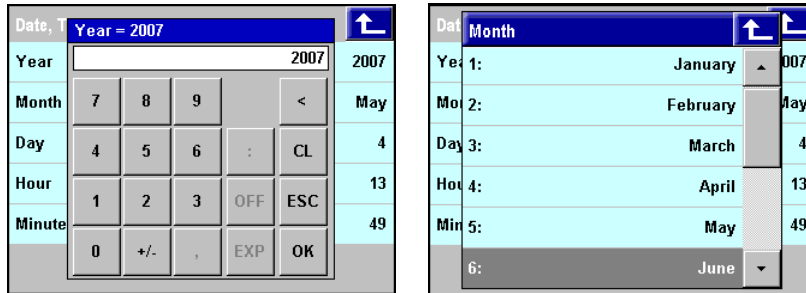

Fig. 31: Year and month selection

Device Data

In the *Device Data* menu configure the network and change device settings (language and screen settings)

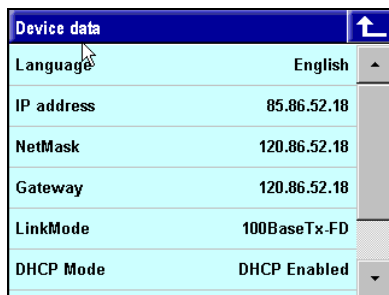

Fig. 32: Menu "Device Data"

- **Language:** Tap on the menu option *Language* to change the device language. Input is executed with the list selection editor.
- **Brightness/contrast:** Tap on the menu options "Brightness" or "Contrast" to change the screen settings. Input is executed with the numerical value editor.



NOTE!

Information on changing the network settings is provided in section "I-5.6 Configure network".

Info

In the *Info* menu you will find information about the software release version that can be useful when requesting service.

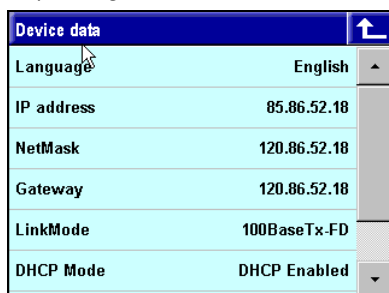

Fig. 33: Menu "Info"

- **Op-Version:** Version of the PMA library on the *KS 108*.
- **FW-Version:** Version of the firmware.
- **HW-Code:** Hardware code of the device. The hardware code is a unique device designation.

I-5.6.1 Configure network

If you are using an Ethernet connection for communication with the *KS 108* then you must configure network settings. To do this, proceed as follows:



NOTE!

Contact your system administrator to determine the type of your network or the type of network connection of the *KS 108*.
Only make changes to the network configuration if you are aware of all necessary network parameters. An incorrect device network setting suppresses device communication and can cause general network malfunctions (e.g. double assignment of IP-Addresses).

Enter IP-Address

With the device you can either assign a permanent IP-Address, or you can have an address assigned dynamically via a DHCP server. Additional information on the "DHCP" option is available below. A fixed IP-Address is assigned as follows:

1. **Call the "General Data" menu:** Call the submenu "General Data".
2. **Call the "General Data" menu:** Call the "Device Data" submenu.
3. **Select the "IP-Address menu command:** Tap on the menu command "IP-Address". The current IP-Address is displayed on the right side of the button.

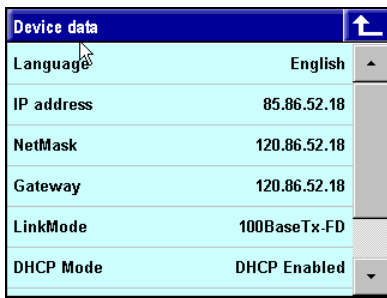

Fig. 34: Menu "Device Data"

4. **Enter the IP-Address:** Enter the new IP-Address with the numerical value editor. Tap on the "OK " button to save your entry.

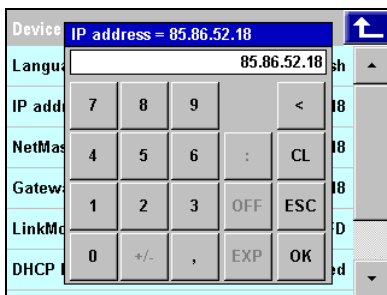

Fig. 35: Enter IP-Address

Enter the network mask

1. **Call the "General Data" menu:** Call the submenu "General Data".
2. **Call the "General Data" menu:** Call the "Device Data" submenu.
3. **Select the "NetMask" menu command:** Tap on the menu command "NetMask". The current IP-Address is displayed on the right side of the button.

Device data		↑
Language	English	▲
IP address	85.86.52.18	
NetMask	120.86.52.18	
Gateway	120.86.52.18	
LinkMode	100BaseTx-FD	
DHCP Mode	DHCP Enabled	▼

Fig. 36: Menu "Device Data"

4. **Enter the netmask:** Enter the new netmask with the numerical value editor. Tap on the "OK " button to save your entry.

Device: NetMask = 120.86.52.18		↑
Language	120.86.52.18	sh ▲
IP address	7 8 9 <	18
NetMask	4 5 6 : CL	18
Gateway	1 2 3 OFF ESC	18
LinkMode	0 +/- , EXP OK	D
DHCP		sd ▼

Fig. 37: Enter NetMask

Enter the gateway IP-Address:

1. **Call the "General Data" menu:** Call the submenu "General Data".
2. **Call the "General Data" menu:** Call the "Device Data" submenu.
3. **Select the "Gateway" menu command:** Tap on the "Gateway" menu command. The current gateway is displayed on the right side of the button.

Device data		↑
Language	English	▲
IP address	85.86.52.18	
NetMask	120.86.52.18	
Gateway	120.86.52.18	
LinkMode	100BaseTx-FD	
DHCP Mode	DHCP Enabled	▼

Fig. 38: Menu "Device Data"

4. **NetMask input:** Enter the new gateway with the numerical value editor. Tap on the "OK " button to save your entry.

Device: Gateway = 120.86.52.18		↑
Language	120.86.52.18	sh ▲
IP address	7 8 9 <	18
NetMask	4 5 6 : CL	18
Gateway	1 2 3 OFF ESC	18
LinkMode	0 +/- , EXP OK	D
DHCP		sd ▼

Fig. 39: Input gateway

Configuring the network connection type

Use the "LinkMode" setting to specify the Ethernet standard that your network works with. Normally you can use the "Auto" setting. However if problems should occur you can also explicitly specify the type of network connection.

The following options are available:

Option	Explanation
Auto	The communication parameters will be determined automatically.
100base-Tx FD	100 Mbit/s, full duplex
100base-Tx HD	100 Mbit/s, half duplex
10base-T FD	10 Mbit/s, full duplex
10base-T HD	10 Mbit/s, half duplex

Proceed as follows to configure the network connection type:

1. **Call the "General Data" menu:** Call the submenu "General Data".
2. **Call the "General Data" menu:** Call the "Device Data" submenu.
3. **Select the "LinkMode" menu command:** Tap on the "LinkMode" menu command. The current network connection type is displayed on the right side of the button.

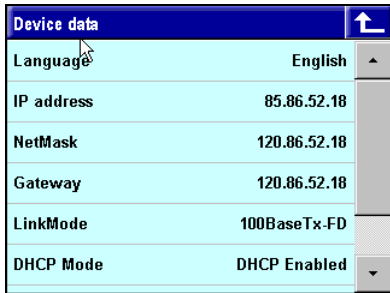

Fig. 40: Menu "Device Data"

4. **Select LinkMode:** Select the new network connection type in the list selection editor.

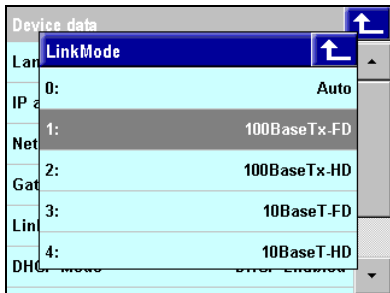

Fig. 41: Specify LinkMode

Configure DHCP mode

If the *KS 108* will not be working with a fixed IP-Address, but rather with an IP-Address that is dynamically assigned by a DHCP server, then the steps below are necessary:

1. **Call the "General Data" menu:** Call the submenu "General Data".
2. **Call the "General Data" menu:** Call the "Device Data" submenu.
3. **Select the "DhcpMode" menu command:** Tap on the "DhcpMode" menu command. The current status is displayed on the right side of the button.

Device data	
Language	English
IP address	85.86.52.18
NetMask	120.86.52.18
Gateway	120.86.52.18
LinkMode	100BaseTx-FD
DHCP Mode	DHCP Enabled

Fig. 42: Menu "Device Data"

4. **Select DhcpMode:** Select the desired mode in the list selection editor.

Device data	
Language	English
IP address	85.86.52.18
NetMask	120.86.52.18
Gateway	120.86.52.18
LinkMode	100BaseTx-FD
DHCP Mode	DHCP Enabled

Fig. 43: Specify DhcpMode

I-5.7 Operating pages

Operating pages are made available through the PMA library. They provide information about the current status of the program and enable (as the name indicates) operation of the application program. Application development determines exclusively which operating pages can be found in an application program.

The following section offers an overview of the types of operating pages that are available.



NOTE!

General information only is provided here for understanding and using the operating pages. Fundamental information on the PMA library is available in the chapter "Function library".

I-5.7.1 Operating page V_ALARM

The alarm page provides an overview of alarm messages. There are two different types of alarm messages:

- **Alarms with acknowledgement:** These are alarms that must be confirmed by the user.
- **Alarms without acknowledgement:** These alarms must be confirmed by the user by clicking on a button.

Alarms are displayed as long as they are active. All alarms and all status changes of an alarm are stored in a history file.

Properties

- **Alarm overview:** The dialog offers a tabular overview of all alarm messages.
- **Alarms acknowledge:** Alarm messages can be acknowledged.
- **Save the alarm history:** The alarm history can be copied to a USB stick.
- **Delete alarm history:** The alarm history can be deleted.

 **NOTE!**
Additional information on the "V_alarm" operating page is available in the function block reference.

Overview

- 1 Title
- 2 Button "Leave Operating Page"
- 3 Button "Service"
- 4 Non-acknowledged active alarm (red) that must be acknowledged.
- 5 Active alarm (red) that does not need to be acknowledged, or that has already been acknowledged.
- 6 Alarm (black) that is no longer active which must be acknowledged.

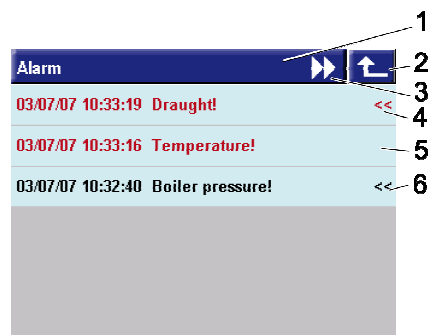



Fig. 44: Alarm page

 **NOTE!**
The characters "<<" indicate alarms that must be acknowledged.

Operation

Call alarm page

The alarm page can be called from all operating pages via the "Alarm" button. If an alarm is not active then this triangle is gray, an active alarm is signaled by a flashing red warning triangle. The alarms are displayed with a plant-specific text, in the sequence of their occurrence.

- **Call:** Click on the "Alarm" button (Fig. 45/1) to call the alarm page.

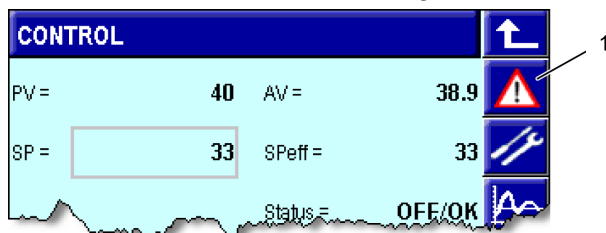

Fig. 45: Active alarm

**NOTE!**

If alarm messages are present then you will see a red flashing warning triangle (⚠) on the "Alarm" button. Otherwise the triangle is gray.

Confirm alarm

- **Acknowledge an alarm:** If the alarm must be acknowledged then the message "Alarm Quit" is displayed. Tap on the "OK" button to acknowledge the alarm.



Fig. 46: Confirm alarm

Delete alarm history

Alarms and alarm status changes are stored on the SD card of the KS 108. On the operating page "Service Alarm Files" you will see information on the storage media (total memory and free memory) and you can copy or delete the alarm data.

1. **Call "Service-alarm" operating page:** Tap on the button "Service" (Fig. "Alarm page"/3). Now you will see the operating page "Service - alarm files".
2. **Delete alarms:** Tap on the "Delete" button if you want to delete the alarm messages on the SD card.

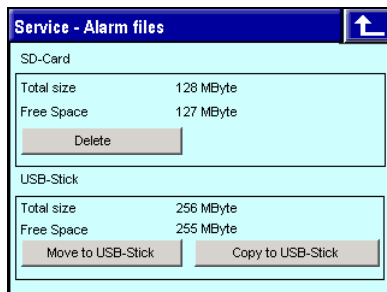

Fig. 47: Alarm page (dialog "Service – Alarm Files")

Alarm history - copy/move alarms

On the alarm page the current alarms and the alarms that must be acknowledged are displayed. If you want to see the alarm messages in chronological sequence, you must copy the messages to a USB stick and open the file in *Microsoft Excel* for example.

To do this, proceed as follows:

**CAUTION!****Danger of data loss!**

Removal of the USB stick during the copy process can result in data loss. The file structure of the USB stick, as well as device data structure can be damaged.

Therefore:

- Only pull the USB stick out if it has been unmounted (when the display of the remaining storage space goes out).

1. **Call "Service-alarm" operating page:** Tap on the button "Service". Now you will see the operating page "Service - alarm files".
2. **Insert the USB stick:** Carefully lift the cover of the USB connection (Fig. 48/1) on the front of the device and turn it to the side. Now insert the USB stick (Fig. 48/2) in the connection (Fig. 48/3).

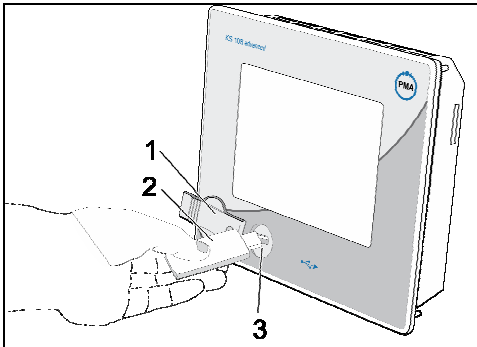

Fig. 48: Using the USB stick

The USB stick should be automatically detected, the remaining storage space on the stick will be displayed after a few seconds. The buttons for saving to the USB stick are displayed after the storage medium has been integrated.

3. **Start copy/move:** Tap on the "Move to USB stick" button if you want to move data to the USB stick. The data on the SD card will be deleted in this process.
Tap on the "Copy to USB stick" button if you want to copy data to the USB stick. The data are stored on the SD card.



NOTE!

After copying the USB stick is unmounted. Consequently the display of the remaining storage space on the USB stick goes out. The buttons for saving to the USB stick are hidden. If you want to copy additional data to the stick, you must remove the stick and then re-insert it in the USB connection.

Alarm history files are CSV files (CSV: "Comma Separated Values") and have the extension "*.alm". The file on the USB stick contains a time stamp so that files that may already be on the USB stick are not overwritten. The copied file can be edited for example with *Microsoft Excel*.
The maximum file size of the alarm file on the SD card is determined exclusively by the available storage space on the SD card.

I-5.7.2 Operating page V_DISPLAY

The "V_DISPLAY" operating page can display up to six analog or digital values in six lines. Optionally the values can also be edited.



NOTE!

The precise design of the operating page depends exclusively on the application environment. Thus below you will find only an overview of operating elements that can be used.

Properties

The operating page can contain the following elements:

- Display fields (analog, digital, time, text)
- Input fields (analog, digital, time, text)
- Buttons (buttons, switches, menu)
- Radio buttons
- Any number of screen pages

Inputs can only be made for elements for which this function has been enabled by the application developer.



NOTE!

Additional information for the user display is available in the function block reference in the chapter "V_Display".

Overview and operation

- 1 Title
- 2 Switch "Toggle": Switch over one logical value with one click.
- 3 Display "Toggle":
- 4 Value display
- 5 Input field: One click on the field opens the numerical value editor.
- 6 Button "Leave Operating Page"
- 7 Button "Alarm"
- 8 Button "Call Operating Page"
- 9 Button "Previous page": The previous screen page will be called.
- 10 Button "Next page": The next screen page will be called.
- 11 Radio buttons: Select a value with a single click on the desired value. Only one element can be selected.

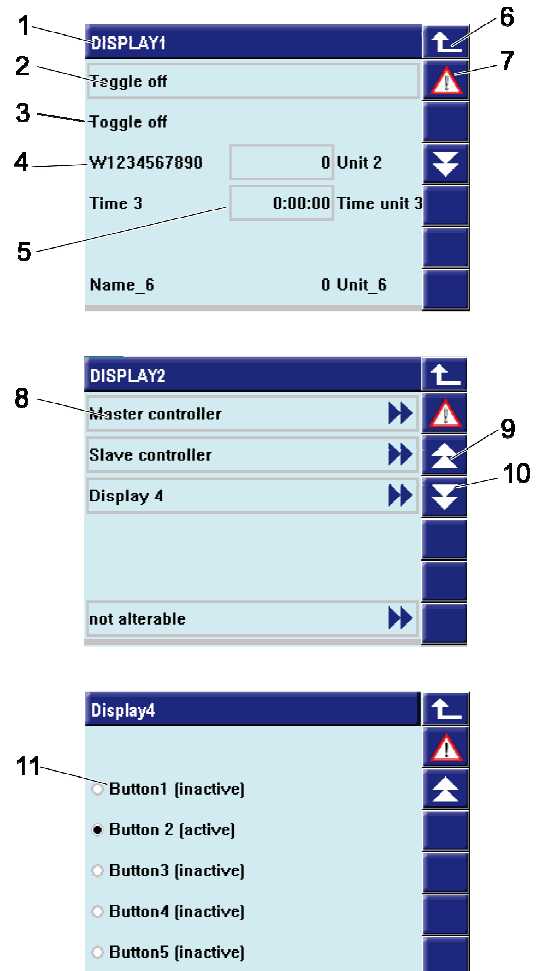

Fig. 49: User display

I-5.7.3 Operating page V_BAR

Use the "V_BAR" operating page to visualize two analog values as a bargraph.

Properties

- **Bar graph display:** Two analog values can be displayed as a vertical or horizontal bargraph. If a range is underranged then an arrow appears at the beginning or end of the bargraph (◀ or ▶).
- **Numerical value display:** Two additional analog values can be displayed as numerical value and changed if necessary. These numerical values can be identical to the values visualized in the bargraphs, however this is not mandatory.
- **Marker:** With four additional values (analog inputs) it is possible to define two markers for each bargraph. These markers are displayed in red on the bargraph for emphasis.



NOTE!

Additional information on the "Bargraph" operating page is available in the function block reference.

Overview

- 1 Title
- 2 Name of the value displayed in the bargraph
- 3 Scale value of the bargraph
- 4 Origin of the bargraph
- 5 Unit of the displayed value
- 6 Bargraph
- 7 Button "Leave Operating Page"
- 8 Button "Alarm"
- 9 Display and input field for the value
- 10 Limit value marks for the bargraph

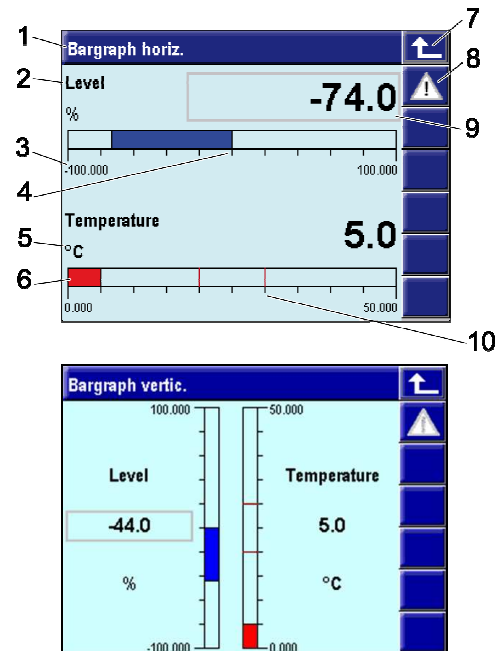

Fig. 50: Bargraph (horizontal and vertical)

Operation

Entering values

If this has been provided by the developer of the application program then values can be entered in the display and input field (see Fig. "Bargraph"/9). Note: If value input is possible then the field will have a frame. Tap the field to enter a value.

I-5.7.4 Operating page V_LOGGING

With the "V_LOGGING" operating page the trend of analog and digital values can be recorded.

Properties

- **Logging:** 12 digital tracks and 6 analog tracks can be recorded. The scan time is specified by the application developer.
- **Data storage on SD card:** The data are stored on an SD card. The maximum file size as well as the number (100 maximum) of files used for data storage are specified here by the application developer. After the last file has been described up to the maximum file size, the system will start again with the first file. The files are numbered consecutively. The number is appended to the file name.
- **Copy:** The logging files can be copied to a USB stick.



NOTE!

Additional information on the "V_LOGGING" operating page is available in the function block reference.

Overview

- 1 Title
- 2 Name of the output file
- 3 Current size of the output file
- 4 Remaining free storage space on the SD card
- 5 Remaining free storage space on the USB stick (this is only displayed if a USB stick is connected to the device)
- 6 Button "Leave Operating Page"
- 7 Button "Alarm"
- 8 Call button "Start/stop recording". Depending on the application development this button may not be visible.
- 9 Button "Copy"
- 10 Status display ("run": Datalogger is running, "off": Data logger stopped)
- 11 Input field "File name"
- 12 Input field "Header"
- 13 Status message

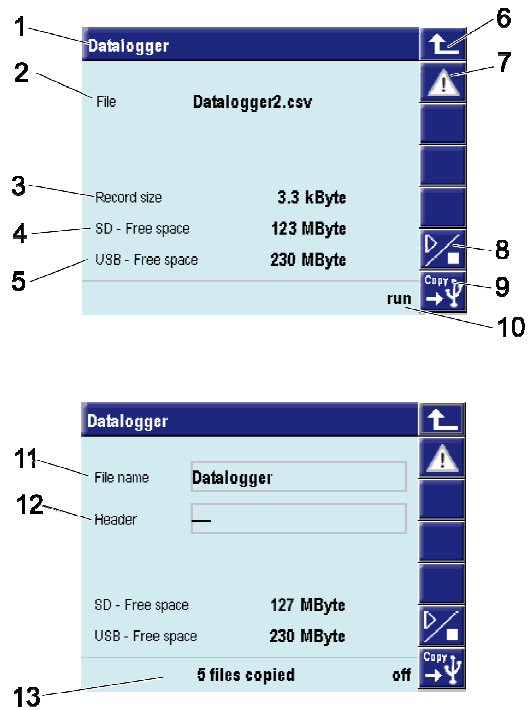

Fig. 51: Data logger (overview, input file name, copy)

Operation

Start recording

If the recording is not yet running (the status display shows the value "off") you can start the recording as follows:

1. **Start recording:** Tap on the button "Start/stop recording" (Fig. "Data logger"/8), to start the recording.
2. **Specify file name/comment:** Tap on the fields "File name" or "Header" to enter the file name of the header/comment. The comment appears as the first line of the output file. Use the "Text input" dialog to make the input.

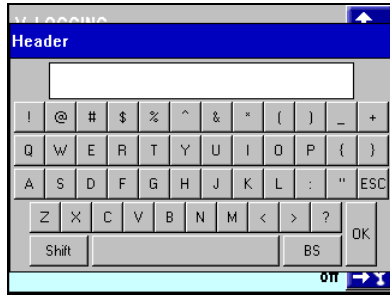

Fig. 52: Entering a header

Ending the recording

If the recording is running (the status display shows the value "run") you can stop the recording as follows:

1. **Ending the recording:** Click on the button "Start/stop recording" (Fig. "Data logger"/8).

Exporting a file

You can copy the files to a USB stick. The file name of the copied file has a time stamp e.g. "V_LOGGING_20070420_123439.csv". This ensures that an old file is not overwritten by a new one on the USB stick.

The log file is a CSV file (CSV: "Comma Separated Values"). The file can be edited, for example with *Microsoft Excel*.

Proceed as follows to copy a file:



CAUTION!

Danger of data loss!

Removal of the USB stick during the copy process can result in data loss. The file structure of the USB stick, as well as device data structure can be damaged.

Therefore:

- Only pull the USB stick out if it has been unmounted (when the display of the remaining storage space goes out).

1. **Inserting the USB stick:** Carefully lift the cover of the USB connection (Fig. 53/1) on the front of the device and turn it to the side. Now insert the USB stick (Fig. 53/2) in the connection (Fig. 53/3).

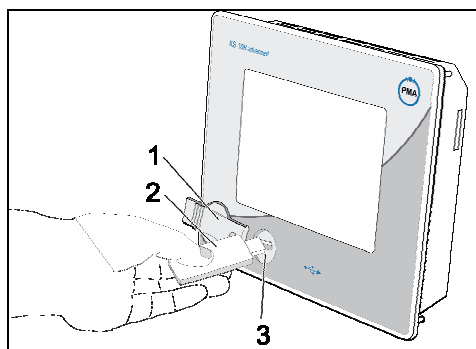

Fig. 53: Using the USB stick

The USB stick should be automatically detected, the remaining storage space on the stick will be displayed after a few seconds.

2. **Start copy:** Tap on the "Copy" (Fig. "Data logger"/9), button to start copying. After concluding the copy process the number of copied files will be displayed (Fig. "Data logger"/13). Please note that approximately 20 MB per minute can be copied from the USB stick (transmission of 1 GB takes approximately 50 minutes).

**NOTE!**

After copying the USB stick is unmounted. Consequently the display of the remaining storage space on the USB stick goes out. If you want to copy additional data to the stick, you must remove the stick and then re-insert it in the USB connection.

I-5.7.5 Operating page V_TREND

Use the operating page "V_TREND" to visualize the trend of analog and digital values as a function graph.

Properties

- **Graph display:** Analog or digital values are displayed in their temporal trend.
- **Measured value selection:** The associated axis scaling can be displayed for a trend. Selection is executed via the "Measured value selection" button.
- **Tracks:** A maximum of 12 digital tracks and 6 analog tracks can be recorded.
- **Memory:** A maximum of 10 000 values can be stored (the precise number depends on the configuration of the block).
- **Time grid:** Values are recorded in a fixed time grid. The minimum time grid is 0.2 seconds, the maximum is 3600 seconds (the precise value depends on the configuration of the block).



NOTE!

Additional information on the "V_Trend" operating page is available in the function block reference.

Overview

- 1 Title
- 2 Analog trend curves (the curve is read from right to left)
- 3 Cursor
- 4 Time specification (beginning, at cursor position, end). The specification is made in hours/minutes/seconds.
- 5 Value specification for the selected measured value at the cursor position
- 6 Button "Leave Operating Page"
- 7 Button "Alarm"
- 8 Value range of the selected measured value on the Y-axis
- 9 Button "Call parameter page"
- 10 Button "Cursor to the left"
- 11 Button "Cursor to the right"
- 12 Button xxx
- 13 Button xxx
- 14 Digital tracks

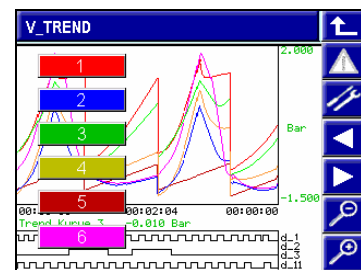
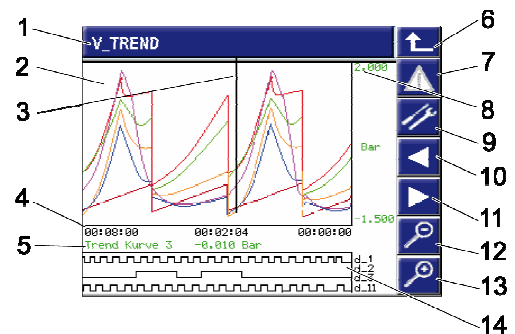

Fig. 54: Trend (Trend curves and measured value selection)

Operation

Measured value selection:

1. **Call "Measured value selection":** Tap right on the free area next to the Y-axis. Now you will see an overview of the available measured values, displayed as a colored rectangle 1-6.

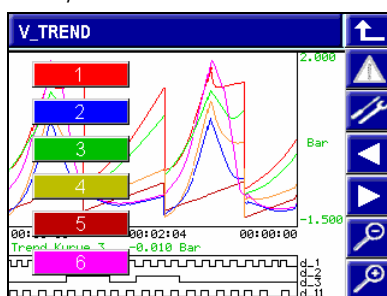

Fig. 55: Measured value selection

2. **Select a measured value:** Tap on one of the rectangles to select the desired measured value. The "Measured value selection" dialog will close. Value specification and axis scaling are adapted to the selected measured value.



NOTE!

The value specifications for the current cursor position always have the color of the corresponding measured value.

Selecting the value specification

Move the cursor to the X axis with the cursor buttons (Fig. "Trend"/7 and 8). The value specification will be adjusted at the selected point in time.

Browse - cursor to the end

Move the cursor on the X-axis to the beginning or end of the display with the cursor buttons (Fig. "Trend"/7 and 8). If more values are stored than are displayed then the system will advance or go back a half page.

Hide / show values

You can show or hide analog and digital values.

To do this, proceed as follows:

1. **Call the "Parameters" operating page:** Tap on the button "Parameters" (Fig. "Trend"/10) to call the "Parameters" operating page.
2. **Call the parameter <Value>:** In the parameter list call the name of the value that you would like to show or hide (e.g. "Display value type1" in the following illustration). You will see a selection list.

V_TREND - Parameter		↑
Step size	1	▲
Start delay	0	■
Display Mode 1	Single	■
Display Mode 2	Single	■
Display Mode 3	Single	■
Display Mode 4	Single	▼

Fig. 56: "V_Trend" parameter

3. **Show / hide value:**
For digital values: In the selection list select the option "off" if the value should not be displayed, or "on" if the value will be displayed.



NOTE!

Hide the digital values to increase space for the analog values.

For analog values: Select the option "off" in the selection list, if you do not want to display the value. Select one of the options "individual", "average", or "min/max" to display the value (additional information on these options is available in the section "Adjusting the display of analog values").

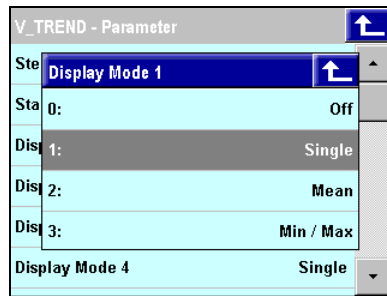

Fig. 57: Hide / show values

Combining analog values

If you would like to view a larger time segment you can combine multiple points into one point. To do this, proceed as follows:

1. **Call the "Parameters" operating page:** Tap on the button "Parameter page" (Fig. "Trend"/10) to call the "Parameters" operating page.

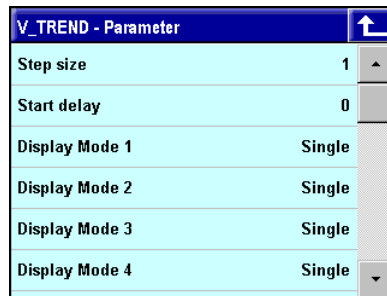

Fig. 58: "V_Trend" parameter

2. **Enter the parameter "Increment":** Tap on the parameter "Increment". Now you will see the numerical value editor. Here enter the number of values that will be combined into one value.

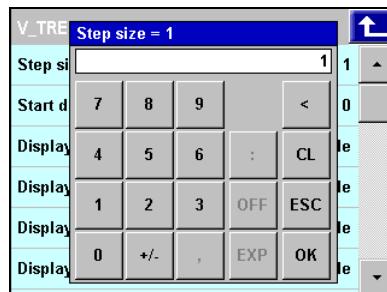

Fig. 59: Enter increment

Adjusting the display of analog values

The display of analog values can be adjusted. The following options are available in this regard:

- **Off:** The value is not displayed.
- **Single:** Multiple points are combined into one point.
- **Average:** The average value of the points that will be combined is calculated and displayed.
- **Min/max:** A line is drawn between the minimum and maximum value of the points that will be combined.

Proceed as follows to select these options:

1. **Call the "Parameters" operating page:** Tap on the button "Parameters" to call the "Parameters" operating page.

V_TREND - Parameter		↑
Step size	1	▲
Start delay	0	
Display Mode 1	Single	
Display Mode 2	Single	
Display Mode 3	Single	
Display Mode 4	Single	▼

Fig. 60: "V_Trend" parameter

2. **Call the parameter <Value>:** In the parameter list (see the Fig. above) call the display type of the value that you want to scale to.
3. **Select option:** Select the desired option from the selection list.

V_TREND - Parameter		↑
Step size	1	▲
Start delay	0	Off
Display Mode 1	Single	
Display Mode 2	Mean	
Display Mode 3	Min / Max	
Display Mode 4	Single	▼

Fig. 61: Select parameter

Specifying the Y-axis value range

You can specify the value range of the Y-axis (for analog values) as follows:

1. **Call the "Parameters" operating page:** Tap on the button "Parameter page" (Fig. "Trend"/10) to call the "Parameters" operating page.

V_TREND - Parameter		↑
Display Mode 12	Off	▲
Scale start X1	0	
Scale end X1	100	
Scale start X2	0	
Scale end X2	100	
Scale start X3	0	▼

Fig. 62: "V_Trend" parameter

2. **Enter the parameter "Value range":** You must first select the measured value to which the display will be scaled. The measured values are consecutively numbered from X1 to X6). For each measured value you can select the lower limit (e.g. "Scale beginning X1") and the upper limit ("Full scale X1"). Select the appropriate menu entry and enter the value range with the numerical value editor (see the following Fig.).

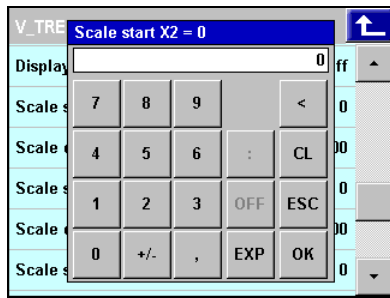



Fig. 63: Entering the value range

I-5.7.6 Operating page CONTROL

The operating page "CONTROL provides information about controllers and process control loops and permits intervention in these control loops (e.g. switch over to manual mode).

The PMA library contains three controllers:

- **Controller "Control"**: The "Control" controller includes a PID controller with numerous functions (e.g. setpoint ramp, setpoint switch over, setpoint/process value tracking, self-optimization, override control, feed-forward control, control variable guidance, ratio control and three-component control in 12 different controller type variants (e.g. continuous, 2-point, 3-point, and motor-step).
- **Controller "Control+"**: The controller basically includes the same functions as the "Control" controller. In addition the "Control+" controller enables guided adaptation. Six parameter sets can be activated depending on process criteria (process value, setpoint, controller output, system deviation) and plant or batch properties. The parameter sets can be determined by self-optimization independent of each other.
- **Controller "PIDMA"**: The PIDMA controller basically corresponds to the "Control" controller. However differences occur due to a different implementation of the PID controller kernel. In this case a different control algorithm and different processes are used for self-optimization.

 **NOTE!**
Additional information on the controller is available in the function block reference.

Properties

- **Target value display/process value display**: Display of target value and process value.
- **Controller output**: The controller output is displayed numerically and as bargraph.
- **Manual mode**: Switch over between automatic mode and manual mode is possible.
- **Self-optimization**: A separate operating page enables the starting of a self-optimization process and provides information about its trend and results.

Overview

- 1 Title
- 2 Display and input field for the setpoint ("SP" = Setpoint")
- 3 Bargraph: Controller output ("AV" = "Actuating Variable"), deviation variable ("DV" = "Deviation Variable") or process value ("PV" = "Process Variable")
- 4 Button "Leave Operating Page"
- 5 Button "Alarm"
- 6 Display process value ("PV" = "Process Variable")
- 7 Button "Call parameter page"
- 8 Button "Call self-optimization"
- 9 Display controller output
- 10 Button "Switch over automatic mode/manual mode"
- 11 Controller parameter set selection (only for Control+)

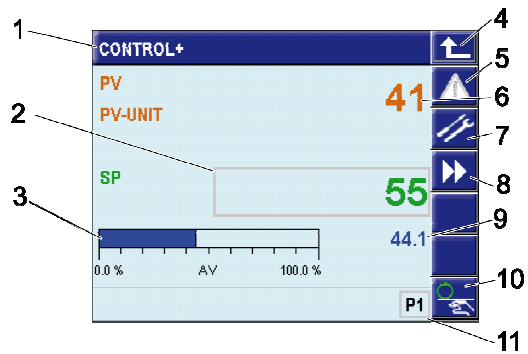

Page Self-optimization

The "Self-optimization" page shows a new button compared with the main page of the controllers:

- 12 Button "Start/stop self-optimization"
- 13 Button "Setpoint switch over" (this button is also available on the main page, if switch over via parameter assignment is permitted).

Field	Description
PV	"Process Variable"/process value
SP	"Setpoint"/ internal setpoint
Popt	Parameter set that will be optimized #
T	Optimization time*
AV	"Actuating Variable"/controller output
SPeff	("Setpoint effective")/effective setpoint
Status	Current status of self-optimization Note: More detailed information on the status display is available in the function block reference.
Ores H	Optimization result - heating
Tu/ Vmax H	Process properties - heating
Ores C	Optimization result - cooling
Tu/ Vmax C	Process properties - cooling
Ores	Optimization result - heating/cooling*
Kp/Tn/Tv	Control parameters*
Orun	Display of "ORun", if the optimization is running, and display of "OErr" is the optimization is defective.

* Only for controller PIDMA

Only for controller CONTROL+

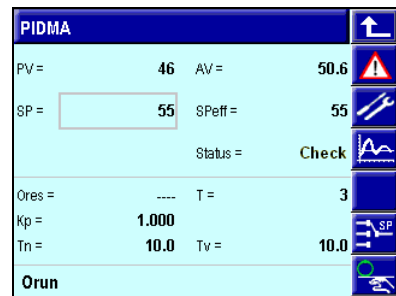
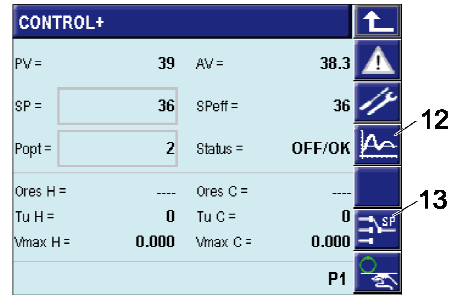

Fig. 64: Controllers "Control"/"Control+" and controller "PIDMA" (controller overview and self-optimization)

Operation

Entering values

If provided by the developer of the application program the operating page has input fields (bordered in gray). Tap on the field to enter a value.

Enter the values either via the numerical value editor (see the section "Using the numeric value editor") or via the following dialog:

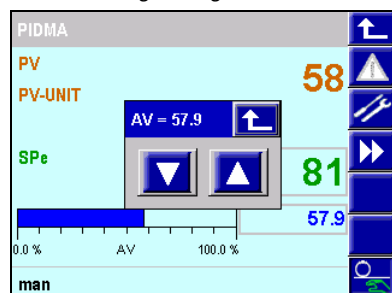

Fig. 65: Entering numerical values

Here tap on the button "▲" or "▼" to increase or decrease the value. The actual value will be displayed in the header.

Working in manual mode

1. **Activate manual mode:** Tap on the button "Switch over Automatic/manual mode" to start manual mode. "man" will be displayed in the status line.

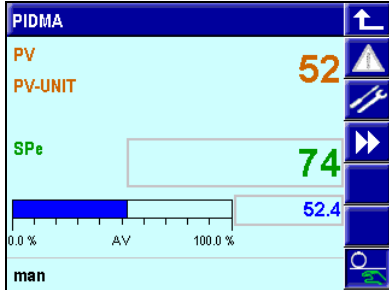

Fig. 66: Working in manual mode

2. **Entering values:** If manual mode is activated then you can enter the desired values manually. To enter values tap on the appropriate field (e.g. "AV").
3. **Ending manual mode:** Tap a second time on the button "Switch over automatic mode/manual mode" to end manual mode.

Starting self-optimization

1. **Call the "Self-optimization" operating page:** Tap on the button "Call self-optimization" (Fig. "Controllers"/8). The "Self-optimization" operating page will be displayed.
2. **Starting manual mode:** Tap on the button (Fig. "Controllers"/10), to change to manual mode.
3. **Setting the setpoint reserve:** Tap on the setpoint and enter a setpoint that is at least 10% above the current actual value.
4. **Starting self-optimization:** If "OFF/OK" is shown in the "Status" field, (i.e. self-optimization is *not* yet running): Tap on the "Call self-optimization" button (Fig. "Controllers"/12), to start self-optimization.



NOTE!

Detailed information on self-optimization of the PIDMA controller is available in the section "PIDMA Self-optimization".

Ending self-optimization

1. **Call the "Self-optimization" operating page:** Tap on the button "Call self-optimization" (Fig. "Controllers"/8). The "Self-optimization" operating page will be displayed.
2. **End self-optimization:** If "OFF/OK" is NOT shown in the "Status" field, (i.e. self-optimization is running): Tap on the "Start/end self-optimization" button (Fig. "Controllers"/12), to end self-optimization.



NOTE!

If this has been provided by the application developer, alternatively you can end self-optimization with the button "Switch over automatic mode/manual mode" (Fig. "Controllers"/10).

Understanding optimization messages

Messages are displayed during the optimization process, these have the following meaning:

Ores1/Ores2 for CONTROL and CONTROL+

Ores1/2	Meaning or cause of the problem	Solution possibility
0	No attempt executed or attempt interrupted by <i>Stop</i> or by switching over to manual mode.	
1	Cancel: Wrong direction of information flow of the actuating variable, X does not change in direction W.	Change the controller's direction of information flow.
2	Terminated: Self-optimization has been successfully executed (point of inflexion found; estimation sure).	
3	Cancel: The controlled variable does not react or is too slow (change of ΔX is less than 1% in 1 hour).	Close control loop.
4	Terminated without <i>AdaErr</i> : Successful attempt, segment has a deep-set point of inflexion.	Best possible result at deep-set point of inflexion.
	Canceled, with <i>AdaErr</i> : Unsuccessful attempt inadequate process stimulation (point of inflexion found, however the estimation is unsafe).	Increase actuating value step <i>dYopt</i>
5	Cancel: Optimization cancelled due to the risk of exceeding the setpoint.	Increase the distance between process value (X) and setpoint (W) at start or reduce <i>YOptm</i> .
6	Terminated: Attempt successful however optimization cancelled due to the risk of exceeding the setpoint (point of inflexion not yet reached; estimation safe).	
7	Cancel: Actuating value step too small, $\Delta Y < 5\%$.	Increase <i>Ymax</i> or set <i>YOptm</i> to a lesser value.
8	Cancel: Sollwertreserve zu klein oder Sollwertüberschreitung während PiR-Überwachung läuft.	Change steadying actuating value <i>YOptm</i> .

Ores for PIDMA

Ores	Meaning or cause of the problem	Solution possibility
0	No attempt executed	
1	Xlimit too small	step threshold too small: Compared to the process noise the step threshold is too small. Start a new attempt with a greater actuating pulse.
2	DYopt large	Actuating pulse too large: The actuating pulse would exceed the selected actuating limits at output of the selected pulse height. A new attempt with a lesser actuating pulse height should be stated, or the actuating variable should be reduced in manual mode beforehand.

3	Restart	No idle state: The auto tuner has detected that the process is probably not in idle state. Please wait until the idle state has been reached. Optionally the drift compensation can be activated or the actuating pulse can be increased. Comment: For pulse width modulated (PWM) control outputs (2-point and 3-point controllers) even in manual mode oscillations of the process value PV can occur if the corresponding cycle time t1 (t2) is too long. In this case you must set the shortest possible switch cycle times on the controller.
4	DYopt small	Actuating pulse too small: The step response declines in the process noise. A new attempt with a greater actuating pulse height should be started, or the overlaid noise should be reduced via suitable measures (e.g. filters).
5	No extremum	Max detection failed: After output of the actuating pulse no maximum/minimum was detected in the process value trend. The settings for the zone type (with/without compensation) should be checked.
6	Actuating limit	Actuating limits exceeded during optimization. The actuating variable MV exceeded the actuating limit during the attempt. The attempt should be repeated in manual mode with a reduced actuating pulse or reduced actuating value.
7	Controller type	No optimization result can be found for the specified combination P/I/D.
9	Monotony	Process not monotone: The process shows pronounced all pass behavior (temporary counter behavior of the process value) or a significant fault occurred.
10	Estimation error	Extrapolation failed: After end of the actuating pulse a drop in the process value was not detected, possibly due to excessive process noise. Increase actuating pulse or attenuate noise.
11	No result	Unusable result: Excessive process noise or the control parameters determined do not agree with the description of a zone with dead time. Start a new attempt with greater actuating pulse or attenuate the existing noise.
12	Man. Cancel:	The optimization attempt has been cancelled by the operator through "STOP".
	Direction	Wrong direction of information flow: The expected direction of information flow of the step response runs counter to the actuating value. This can be due to wrong setting of the direction of information flow, or for example it could be due to inverting final control elements. Change the controller's direction of information flow.

I-5.7.7 Using controllers in controller cascades

Control loops can be broken down into partial control loops (cascade control). Cascade control consists of at least two controllers, a guide controller (master) and a following controller (slave). The master controller specifies the setpoint to the slave controller and thus influences the main control value via the slave controller. If a controller is used as slave controller, then the status display "Cascade or "Casc-open" is shown on the controller page. The PMA library enables convenient operation of a controller cascade on the operating page of the slave controller.

**NOTE!**

Basic information on cascade control is available in the function block reference.

Overview

Fig. 67: Controller cascade

If provided by the developer you can interrupt the cascade, i.e. "open" the cascade. which means use the slave controller(s) independently from the master controller.

- **Open cascade:** If the cascade is closed (in the footer the word "Cascade" is displayed) then tap on the "☐" button to open the controller cascade. The display "Cask open" will be displayed.
- **Close cascade:** If the cascade is open (display in the input field "Casc-open") then tap on the "☐" button to close the controller cascade. "Cascade" is displayed.

I-5.7.8 Detailed information on self-optimization

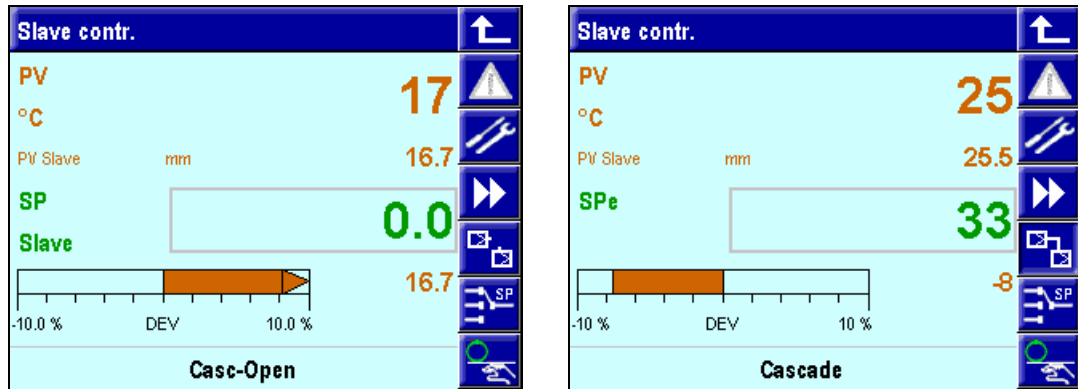
Detailed information on self-optimization of the controllers CONTROL, CONTROL+ and PIDMA is provided in the following section.

I.5.7.8.1 Controller characteristic values (CONTROL and CONTROLP)

To determine the control parameters you must first be aware of the zone data. The zone data are detected automatically by the controller in the self-optimization process and are converted into control parameters. Nevertheless in exceptional cases it can be necessary to manually determine the zone data. The temporal trend of the measured value PV can be referenced after a step-like change of the actuating value AV.

In practical terms, often it is not possible to completely record the step response (0 to 100%) as the measured value cannot exceed certain values. With the values T_g and PV_{max} (step from 0 to 100%) or Δt and ΔPV (part of the step response) the maximum rate of rise V_{max} can be calculated.

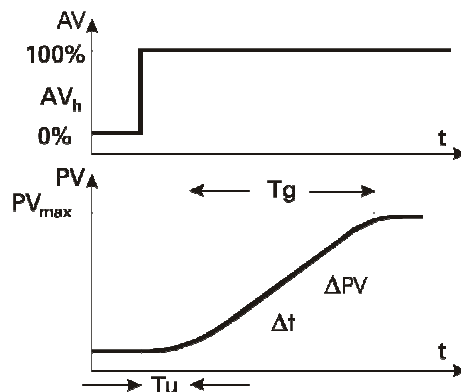

Fig. 68: Characteristic values of the controller zone

$$K = \frac{V_{max}}{PV_h} \cdot T_u \cdot 100\%$$

y = Controller output

AV_h = Correcting range

T_u = Delay time (s)

T_g = Compensation time (s)

$$V_{max} = \frac{PV_{max}}{T_g} = \frac{\Delta PV}{\Delta t} \triangleq \text{max. rate of rise of the}$$

control variable

$PV_{max} \triangleq$ Maximum value of the controlled system

$PV_h =$ Control range = $PV_{hi} - PV_{lo}$

Characteristic values of the controllers

Normally a fast and overshoot-free smoothing to the setpoint is desired. Depending on the controlled system the following control behaviors are useful:

- **PD controller:** Easily controllable zones ($K < 10\%$) should be regulated with PD controllers.
- **PID controllers:** Moderately controllable zones ($K = .10...22\%$) should be regulated with PID controllers.
- **PI controllers:** Zones that are difficult to control ($K < 22\%$) should be regulated with PI controllers.

From the determined values (delay time T_u , the maximum rate of rise V_{max} , the control control range PV_i and characteristic value K) the required control parameters can be determined according to the following "rules of thumb". A more precise setting must be made in accordance with the setting aids. If there is an oscillating run-up to the setpoint then X_p must be increased.

Rule of thumb			
Behavior	$X_p[\%]$	$T_v[s]$	$T_n[s]$
(D)PID	1.7 K	2 T_u	2 T_u
PD	0.5 K	T_u	$\infty = 0000$
PI	2.6 K	0	6 T_u
P	K	0	$\infty = 0000$
3-point step controller PID			
	1.7 K	T_u	2 T_u

Setting aids				
Characteristic value		Control process	Fault	Actuating process
X_p	Greater	More highly attenuated	Slower smoothing	Slower energy reduction
	Less than	Weaker attenuation	Faster smoothing	Faster energy reduction
T_v	Greater	Weaker attenuation	Stronger reaction	Earlier energy reduction
	Less than	More highly attenuated	Weaker reaction	Later energy reduction
T_n	Greater	More highly attenuated	Slower smoothing	Slower energy reduction
	Less than	Weaker attenuation	Faster smoothing	Faster energy reduction

Direct inverse switch over is possible generally, it is executed with the configuration parameter CMode (direction of information flow). The following illustration shows the principle:

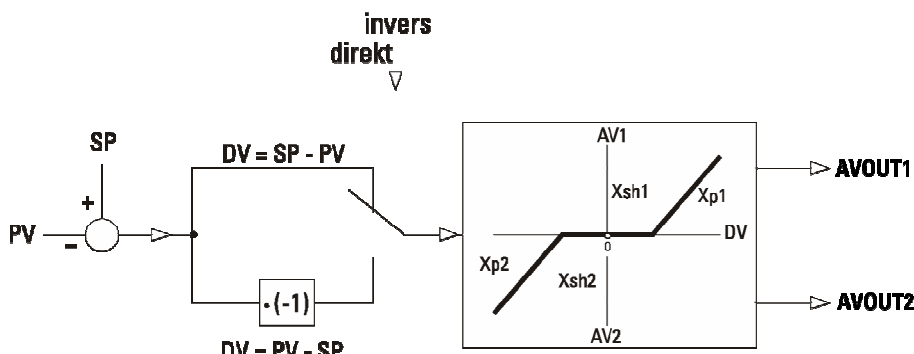

Fig. 69: Principle direct/inverse switch over

I.5.7.8.2 Self-optimization: Controller adaptation to the control zone

Self-optimization can be executed to determine the optimal parameter for a process. This is applicable for control zones with compensation and non-dominating dead time as well as $K \leq 30\%$.

After the user starts the self-optimization the controller executes an adaptation attempt to determine the zone characteristic values T_u and V_{max} . It calculates from this the control parameters for a fast, overshoot-free smoothing to the setpoint.

Detailed information on controller self-optimization is provided in the following section.



NOTE!

The following sections assume that you are familiar with the BlueDesign development environment. Additional information in this regard is available in the chapter "Development environment/working with the development environment". More detailed information on the parameters is available in the function block reference.



DANGER!

Danger of injury due to unforeseeable plant function sequences and movement sequences!

The controller is not functional during self-optimization. Plant parts can be subject to unforeseeable reactions if they are not uncoupled from the device.

Therefore:

The following must be heeded during self optimization:

- All system parts that are switched off must be safeguarded from being restarted inadvertently!
- In general, the effects of switching off the system must be considered, and appropriate measures must be taken.



NOTE!

The graphics in this chapter (e.g. "Fig. 72: "process at rest" monitoring") use deviating variable designations. X is used instead of "PV", and "Y" is used instead of "AV".

Preparation for self optimization

To determine the optimal parameters for a process, you can start self-optimization of the controller. To do this, proceed as follows:

1. **Set control behavior:** Set the following control behavior on the "Self-optimization" page:

Controllers	Behavior
P-controllers	$T_n = 0.0$, $T_v = 0.0$
PD controllers	$T_n = 0.0$, $T_v > 0.0$
PI controllers	$T_n > 0.0$, $T_v = 0.0$
PID controllers	$T_n > 0.0$, $T_v > 0.0$



NOTE!

The parameters " T_n " or " T_v " can be switched off by setting the value 0.0. Thus they do not participate in the self-optimization.

2. **Select parameter set (CONTROL+):** If you use the CONTR+ controller you must now select the parameter set that will be optimized. Select the parameter set in *BlueDesign* with the parameter *POpt* (see the following illustration).

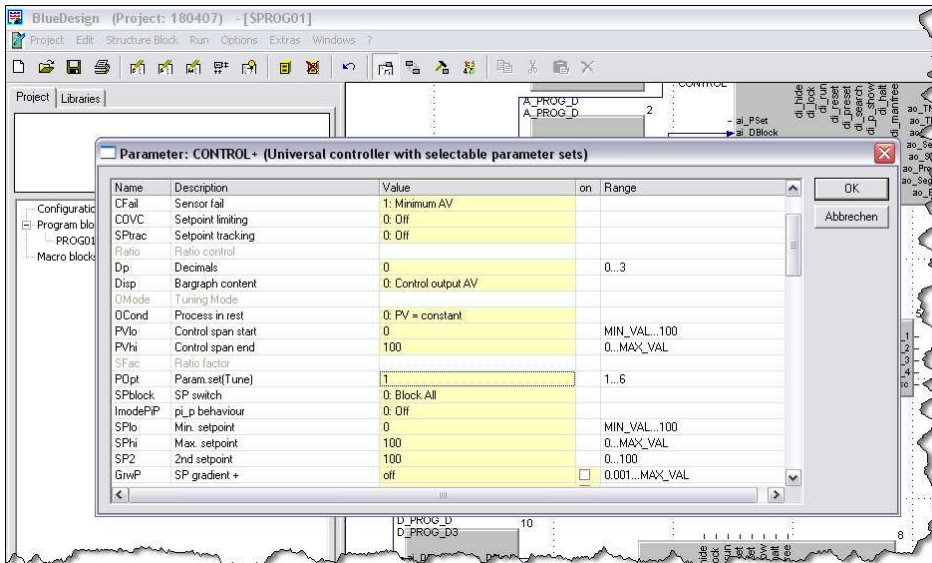

Fig. 70: Select parameter "POpt"

3. **Configuring the conditions for process at rest:** Determine the mode for which the state "process at rest" (*PAR_H*) will be detected in the *BlueDesign* parameter dialog using the *OCond* parameter.

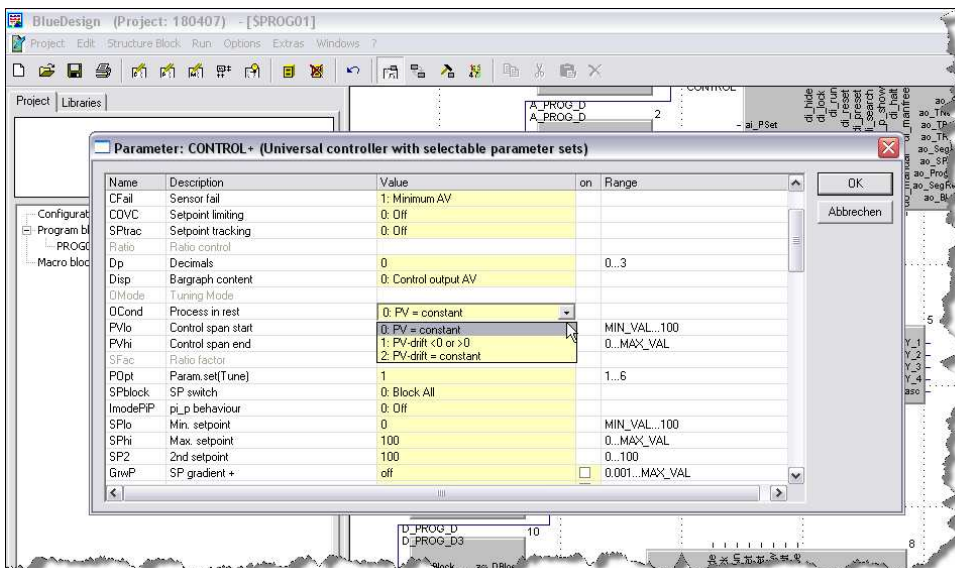

Fig. 71: Select parameter "OCond"

"Process at rest" monitoring is executed consecutively. The process is in rest if the control variable remains within a tolerance band of $\pm\Delta PV = 0.5\%$ for more than 60 seconds:

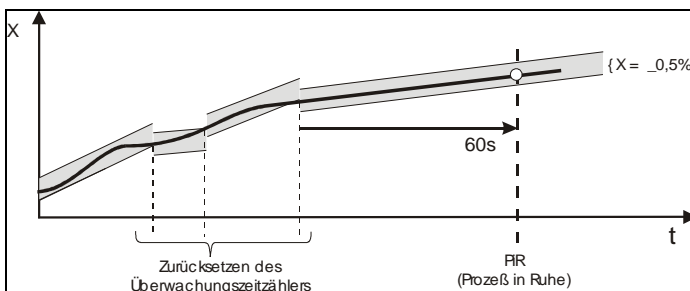

Fig. 72: "process at rest" monitoring

If the process value leaves this tolerance range then the monitoring time counter is reset to zero. If for example in *PaR* is detected in control mode and then when starting self optimization a markedly deviating steady manipulated variable *AVOptm* is output then you must wait until the full *PaR* time interval has elapsed.

Use the configuration word *OCond* to specify the "process at rest" mode - detection, the following options are available:

Parameters	Meaning
PV = constant	The status "process at rest" is detected if the value PV is constant.
PV drift <0 or >0	The status "process at rest" is detected if <ul style="list-style-type: none"> ■ The value PV uniformly decreases with the inverse direction of information flow. ■ The value PV uniformly increases with the direct (non-inverse) direction of information.
PV drift = constant	The status "process at rest" is detected if the value <i>PV</i> changes uniformly.

4. **Specify control variable *AVOptm*:** Specify the control variable *AVOptm* in the *BlueDesign* parameter dialog. This is the start value that is used in automatic mode when starting self-optimization.
5. **Specify the control variable *dAVopt*:** Specify the control variable *dAVopt* in the *BlueDesign* parameter dialog. This parameter determines the value by which the controller output steps. The point of departure in automatic mode is the start value *AVOptm* or in manual mode it is the original controller output.



NOTE!

Pay attention to the necessary setpoint reserve. Self-optimization can only be executed if the interval between setpoint and process value is greater than 10% of the value of "SPlo" and "SPhi", prior to the setpoint step.

The setpoint reserve is either achieved automatically by reduction of the setpoint during the PaR phase (in automatic mode) or via manual change of the setpoint/process value (in manual mode).

Because the setpoint should not be exceeded in the optimization, the setpoint must be greater than the process value for inverse operating controllers, by the amount of the setpoint reserve. For direct working controllers on the other hand the setpoint must be less than the process value by the amount of the setpoint reserve.

Starting self-optimization



Information on starting self-optimization is available in the section "Operating page CONTROL".



NOTE!

Self-optimization can be started from automatic mode or from manual mode.

Cancel the adaptation

- **Click on the button "Switch over automatic mode/manual mode"** If the  button has not been locked (1 signal on the input "di_oplock"), then self-optimization can be ended at any time. Click on the  button to end self-optimization.



NOTE!

Alternatively self-optimization can be stopped in any case via the button "Start/stop self optimization" Additional information in this regard is available in the section "Operating page control".

Self-optimization sequence

Sequence of self-optimization when starting from automatic mode

After starting self optimization the steady state controlled variable $AVOptm$ is output. If "process at rest" (PaR) is detected and a sufficient setpoint reserve (r) is available then the controlled variable can be changed by the controlled variable step $dAVOpt$ (raised for inverse working controllers, lowered for direct working controllers lowered). The process for determining the characteristic value is executed based on the changing process value.

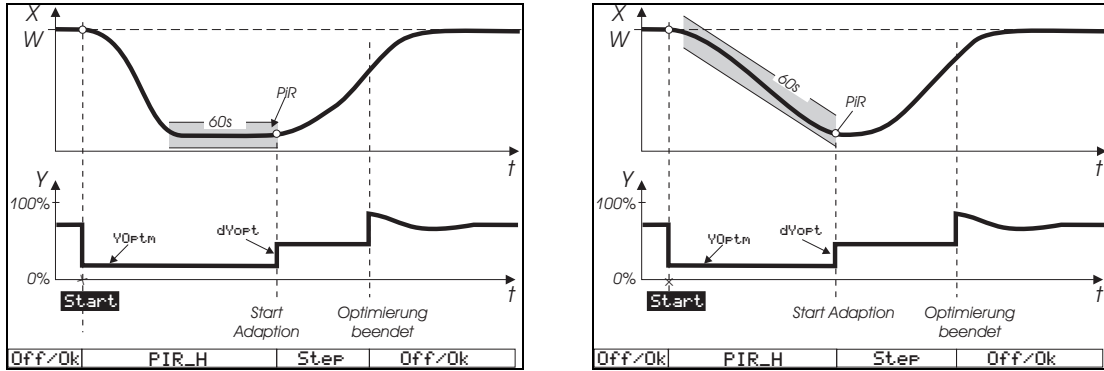

Fig. 73: Self-optimization process in automatic mode

After a successful adaptation attempt the controller goes into automatic mode and controls the setpoint with the newly determined parameters. The parameter $Ores$ indicates the result with which self-optimization has been concluded.



NOTE!

If self-optimization concludes with an error (display: "Ada_Err"), then you must manually end self-optimization mode (see the section "Cancel self-optimization"). As long as self-optimization is not concluded the steady state controlled value will be output.

Sequence of self-optimization when starting from manual mode



NOTE!

A description of how the controller goes into manual mode is provided in the section "Operating page/control".

If the controller is in manual mode then the last used manipulated will be transferred as temporary steady state manipulated value when self-optimization starts. As is the case in automatic mode the setpoint can be adjusted at anytime.

If "process at rest" (PaR) is detected and a sufficient setpoint reserve (r) is available then the controlled variable can be changed by the controlled variable step $dAVOpt$ (raised for inverse working controllers, lowered for direct working controllers lowered). The process for determining the characteristic value is executed based on the changing process value.

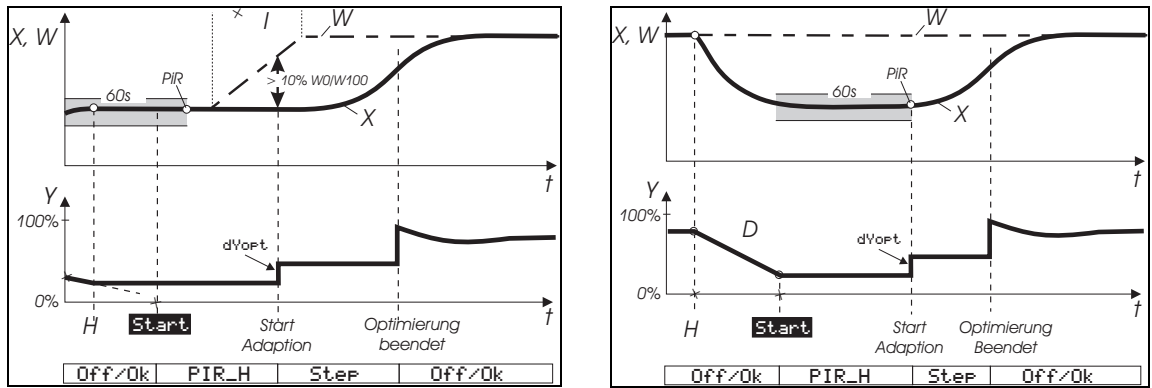

Fig. 74: Self-optimization in manual mode

After a successful adaptation attempt the controller goes into automatic mode and controls the setpoint with the newly determined parameters. The parameter $Ores$ indicates the result with which the self-optimization has been concluded.



NOTE!

If self-optimization concludes with an error (display: "Ada_Err"), then you must manually end self-optimization mode (see the section "Cancel self-optimization"). As long as self-optimization is not concluded the steady state controlled value will be output.

Sequence of self optimization for "heating" type processes.

For 2-point controllers, motor step controllers, and continuous controllers, after achieving the status "process at rest" the control zone is stimulated with a controller output step, and from the process reaction if possible the step response T_{u1} and V_{max1} are determined at the point of inflexion.

Sequence of self optimization for "heating" and cooling type processes.

For 3-point controllers and split-range controllers self-optimization basically runs as described above for the application case "heating". However after controller self-optimization is concluded the system will smooth to the specified setpoint until PaR is reached again. Then to determine the "cooling" zone a step will be initiated in order to then determine T_{u2} and V_{max2} based on the step response. On the basis of these characteristic values the controller will then be set for the "cooling" process. If the attempt is cancelled the parameters of the "heating" zone will also be transferred for the "cooling" zone; no error will be reported.

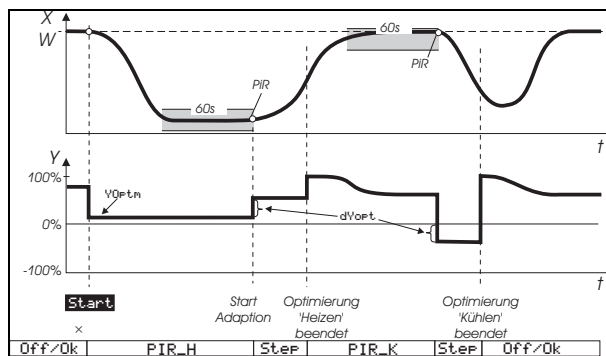

Fig. 75: Self-optimization for "heating" and cooling type processes.

1.5.7.8.3 Controller characteristic values - PIDMA

As opposed to CONTR and CONTR+, PIDMA contains a modified controller kernel in a parallel structure. This results in the following additional parameters.

Additional parameters for PIDMA

Parameters	Description	Value range
PType	Process type (a priori information)	1: with compensation 2: without compensation (integral)
Drift	Drift compensation of the process value at the beginning of self optimization	0: Off 1: On
CSpeed	Desired control loop dynamics	1: Slow 2: Normal 3: Fast
Tpause	Minimum actuating pause time (step controller)	0,1...999999 [s]
thron	Switch on threshold for OPEN and CLOSE (step controller) is not effective	0,2...100%
throff	Switch off threshold for OPEN and CLOSE (step controller) is not effective	0,2...100%
Xlimit	Switch off point for controller output step (process value change)	0,5...999999
Tdrift	Time window for drift determination of the process value	0...999999 [s]
Tnoise	Time window for noise determination of the process value	0...999999
Kp	Control gain (replaces Xp1/Xp2 of the CONTR)	0,001...999,9 [%]
VD	Derivative action gain (Td/T1)	1...999999
bW_p	Setpoint weighting in the P-component	0...1
cW_d	Setpoint weighting in the D-component	0...1
Tsat	Time constant for I-component in AV limitation (anti-reset wind-up)	1...999999 [s]
xsh	Neutral zone in which the I-component is specified	0 ... 999999

Parameter for stepper motor control

Tpause, *thron* and *throff* supplement the parameters for stepper motor activation. *Tpause* in addition to limiting the minimum pulse (*Tpuls*) also allows adjustment of the minimum pause.

With *Xsh* the switch frequency and the fine adjustment of the final control element can be influenced. *Xsh* determines the dead zone of the deviation variable in the main controller. The I-component of the controller is stopped within this zone.

Integrated position controller:

The PIDMA function block includes two controllers for the setting *3-point step PF* (motor step with position feedback):

- **Main controller:** The main controller controls the process value and supplies the desired setting of the final control element to an integrated position controller.
- **Position controller:** This ensures the desired position of the final control element via position feedback.

1.5.7.8.4 Self-optimization PIDMA

Detailed information on self-optimization of the PIDMA controller is provided in the following section.

**NOTE!**

The following sections assume that you are familiar with the BlueDesign development environment. Additional information in this regard is available in the chapter "Development environment/working with the development environment". More detailed information on the parameters is available in the function block reference.

**DANGER!****Danger of injury due to unforeseeable plant function sequences and movement sequences!**

The controller is not functional during self-optimization. Plant parts can be subject to unforeseeable reactions if they are not uncoupled from the device.

Therefore:

The following must be heeded during self optimization:

- All system parts that are switched off must be safeguarded from being restarted inadvertently!
- In general, the effects of switching off the system must be considered, and appropriate measures must be taken.

Parameters - PIDMA

PType, *Drift*, *Cspeed*, *Xlimit*, *Tdrift* and *Tnoise* supplement the parameter *dAVopt* that is also available for CONTR. These parameters specify the conditions for self-optimization.

Start the BlueDesign development environment and edit the parameters of the respective PIDMA block. Ensure that you are not in edit mode.

- **PType** specifies whether for the plant a process without compensation (after an output pulse, a new process value is set on a higher level, e.g. in case of fill level of a container without discharge or of a very well insulated oven). Uniform drop or increase of the process value prior to optimization can be detected via drift monitoring that can be switched on and taken into account for subsequent optimization.
- **CSpeed**: The *Cspeed* specifies whether the setpoint will be achieved with slight overshoot or more slowly with a more gentle approach. With *Cspeed* the parameters can also be switched over after optimization, as long as the control parameters have not been manually changed.
- **Tdrift**: After start of self optimization within the time frame *Tdrift* the system attempts to detect a drift.
- **Tnoise**: After the time frame *Tdrift* in the time frame *Tnoise* the system attempts to detect the noise (the output value dependent fluctuations) on the process value.

**NOTE!**

Depending on the plant, the times "*Tdrift*" and "*Tnoise*" must be selected large enough that fault-dependent drift and multiple fluctuation of the interference influences can be detected.

- **dAVopt, PVlimit**: After these times the actual output value will be increased by **dAVopt**. If the actual value has then increased by more than **PVlimit** with consideration of drift and noise, then the output value will be reset to the original value. The self-optimization process is only concluded if the actual value after exceeding the maximum, has decayed to virtually half of the initial value. During the decay process (after the output value pulse) the estimated remaining time until the end of optimization is continuously displayed. After conclusion of the process the determined parameters *K*, *Ti* and *Td* are displayed on the optimization page, and together with the parameters *VD*, *BW_p* and *CW_d* are automatically transferred into the function block and activated for the running process.

Control parameters of the PIDMA

As opposed to CONTR the PIDMA does not have any special parameters for the application cases "heating" and "cooling". The parameter K , which is valid for both areas determines the control gain of a parallel controller structure.

Additional parameters permit independent weighting of individual controller components:

- **VD:** Derivative action gain ($Rd/T1$) in addition to the control gain permits superelevation or weakening of the D-component.
- **BW_p:** Setpoint weighting in the P-component
- **CW_d:** Setpoint weighting in the D-component

The parameters BW_p and CW_d can weaken the influence of a setpoint change on the controller reaction. Thus it is possible to set different behavior of the controller in response to setpoint changes (guide behavior) or to actual value changes (interference behavior). The setpoint influence can be loaded with a factor between 0 and 1.



NOTE!

In cases where self-optimization of the controller seems to be necessary use the PMA software PMATune. Contact the manufacturer for more information about PMATune.



NOTE!

In the dynamic trend of a controller the control algorithm can also temporarily determine values less than 0 or greater than 100 for the output value. These can be restored to the limit values (0 and 100) as needed with an accelerated integral behavior (" T_{sat} " = time constant for the I-component in an AV limitation/anti-wind-up)

Preparation for self optimization

To determine the optimal parameters for a process you can start the self optimization of the controller. Proceed as follows for this:

1. **Set the control behavior:** Set the following control behavior on the "Self-optimization" page:

Controllers	Behavior
P-controllers	$T_n = 0.0, T_v = 0.0$
PD controllers	$T_n = 0.0, T_v > 0.0$
PI controllers	$T_n > 0.0, T_v = 0.0$
PID controllers	$T_n > 0.0, T_v > 0.0$



NOTE!

The parameters " T_n " or " T_v " can be switched off by setting the value 0.0. Thus they do not participate in the self-optimization.

2. **Specify output value step:** In the *BlueDesign* parameter dialog (see the following illustration) specify the output value step $dAvopt$. The output variable will step by this value starting from the actual value.
3. **PVlimit determination:** In the *BlueDesign* parameter dialog (see the following illustration) specify the *PVlimit* parameter. This parameter must be approximately set to half of the expected change in the process value.

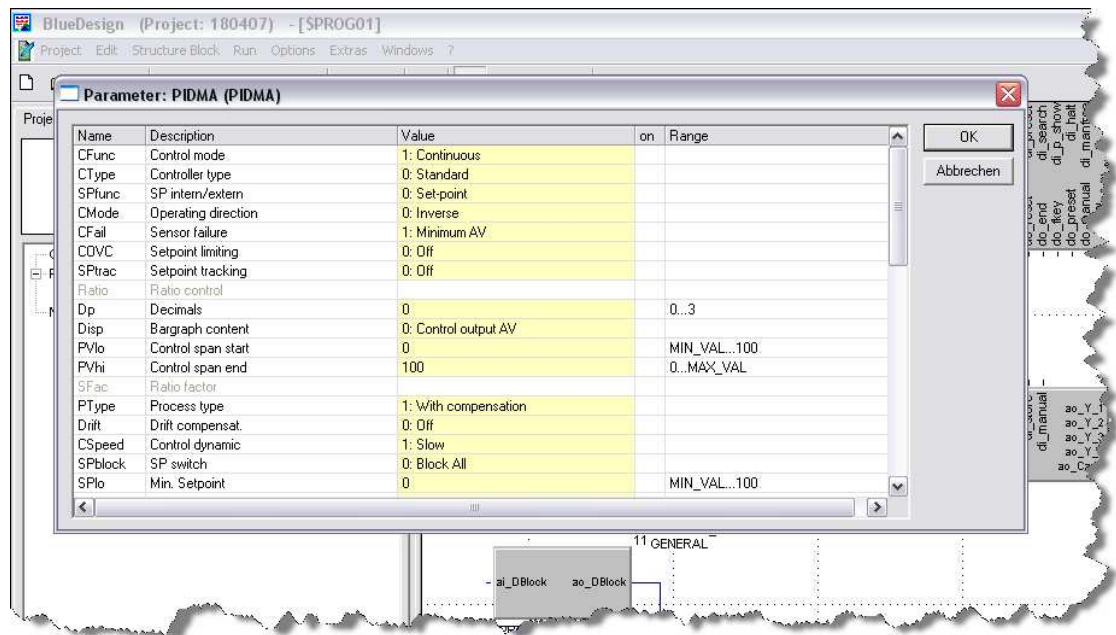

Fig. 76: BlueDesign parameter dialog

"Process at rest" monitoring

The PIDMA does not monitor the rest condition. It is up to the user's discretion to select the suitable start time. You will only obtain optimal results if the process is smoothed, i.e. all dynamic process have decayed. Only in rare cases, where parameter determination is impossible due to decaying dynamics, will the algorithm return the error message "restart".

Starting self-optimization



Information on starting self-optimization is available in the section "Operating page CONTROL".



NOTE!

An adjustment of the setpoint for a start from automatic mode results in a wrong evaluation of the process. However the setpoint can be changed at any time during the self optimization. However as opposed to the CONTROL controller this is not necessary.

Cancellation of self optimization

- Click on the button "Switch over automatic mode/manual mode" If the  button has not been locked (1 signal on the PIDMA input "di_oplock"), then the self-optimization can be ended at any time. Click on the  button to end self-optimization.



NOTE!

Alternatively self-optimization can be stopped in any case via the button "Start/stop self optimization" Additional information in this regard is available in the section "Operating page control".

Start in manual mode or in automatic mode

The PIDMA optimization algorithm does not distinguish between a start in manual mode or a start in automatic mode. In either case you must ensure stable conditions in the plant,

Nevertheless in most cases better optimization results are obtained in manual mode. The reason is that in manual mode usually conditions are achieved in the plant that are more stable, because in automatic mode

the PIDMA controller regulates with parameters that have not yet been optimized until the beginning of the controller output pulse.

For transition to manual mode the last controller output is transferred as manual controller output and maintained during the estimation times.

PIDMA optimization sequence

1. After starting the self-optimization process first drift detection and then noise signal detection is executed.
2. In the second phase the controller output will be changed by the step-wise change $dAVOpt$. If the process value has changed by more than $PVlimit$ then the controller output will be reset to the original value.
3. In the third phase the PIDMA waits for the maximum value of the rising process value.
4. Thereafter it observes the process value in the fourth phase of decay. During this period an assessment of the remaining time until conclusion of the optimization attempt is output.
5. After a successful adaptation attempt the controller goes into automatic mode and controls the setpoint with the newly determined parameters. The parameter $Ores$ indicates the result with which self-optimization has been concluded.



NOTE!

If self-optimization concludes with an error (display: "Ada_Err"), then you must manually end self-optimization mode (see the section "Cancel self-optimization"). As long as self-optimization is not concluded the steady state controlled value will be output.



NOTE!

After successful self-optimization the parameter "CSpeed" can be used to achieve stronger or weaker attenuation if the system was optimized with the setting for "CSpeed = Normal". In addition merely an increase or reduction of "kP" should be considered. After manual change of the control parameters switch over of "CSpeed" no longer has an effect. The parameter "CSpeed" is changed in the BlueDesign parameter dialog.

Sequence of self-optimization for heating and cooling processes

For 3-point controllers, split-range controllers, and their mixed forms different control gains cannot be specified with PIDMA for heating and cooling. Consequently there is no two-phase optimization attempt in this case.

I-5.7.9 Operating page A_PROG

The operating pages of the analog program generator ("A_PROG") provide information about the running programs and permit interventions in the program.

Properties

- **Process value display:** The process value of the current track will be displayed.
- **Runtime display:** The remaining runtime for recipe and segment, as well as total runtime of the recipe are displayed.
- **Manual mode:** If provided by the application developer switch over between automatic mode and manual mode is possible.
- **Function switch:** Freely configurable button.
- **Change programs/recipes:** The user can intervene directly in the program execution and can also change recipes.



NOTE!

Additional information on the program generator is available in the function block reference.

Overview

- 1 Title
- 2 Recipe name
- 3 Setpoint (SP)
- 4 Physical unit
- 5 Segment number and segment value range (beginning value and end value)
- 6 Net program time
- 7 Remaining program time
- 8 Remaining segment time
- 9 Button "Leave Operating Page"
- 10 Display process value (PV)
- 11 Button "Alarm"
- 12 Button "Call parameter page"
- 13 Button "Track change"
- 14 Button "Supplemental commands"
- 15 Button "Function key"
- 16 Button "Change operating mode"
- 17 Status line program generator (operating states: "end", "run", "reset" and "stop")

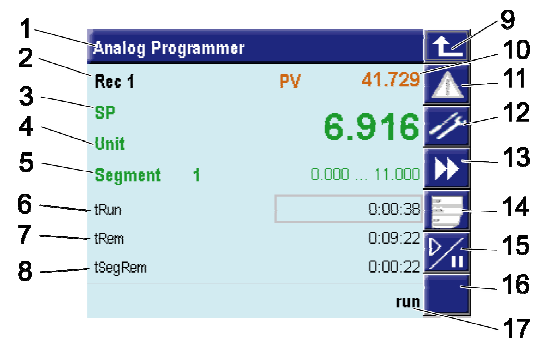

A_PROG - Parameter	
Recipe	Rec 1
Reset setpoint	0
Segment type 1	Time
Time/Gradient 1	10:00:00
Setpoint 1	50
Segment type 2	Time

Fig. 77: Program generator (overview and parameters)



NOTE!

The button "Function key" (Fig. 77/15) depends on the application configuration. A typical use of the function key is program start and program stop. Additional (general) information is available in the function block reference, more detailed information on using the function key in its application is provided in the application documentation.

Operation



NOTE!

Operation of the program generator depends on the application development. Therefore the following descriptions should only be understood as examples. More detailed information on operating the application is provided in the documentation for the respective application.

Select status

The program generator can take on four states:

- **stop:** The program generator has been stopped.
- **reset:** The program generator has been stopped and has been reset to segment 0 of the recipe.
- **run:** The program generator has been started.
- **error:** A program error has occurred.
- **end:** The program generator has reached the end of the program.

Proceed as follows to change the status of the program generator:

1. **Call the "Commands" selection list:** Tap on the button "Supplemental commands" (Fig. "Program generator"/14).
You will see a selection dialog; the commands displayed here depend on the actual operating status of the application and the program configuration.

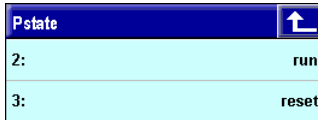

Fig. 78: Selection list "Pstate"

2. **Select command:** Select the desired command here.

Select recipe



NOTE!

The possibility of selecting a recipe in accordance with the following description depends on the application environment.

The recipe can be changed via the program generator. Note that recipes can only be changed if the program generator is in the "reset" state. To do this, proceed as follows:

1. **Call the "Command" selection list:** Tap on the button "Supplemental commands" (Fig. "Program generator"/14).
2. **Select "Stop" status:** Select the status "stop".

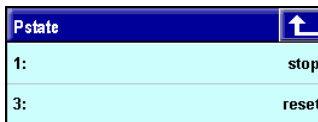

Fig. 79: Selection list "Pstate"

3. **Select "Reset" status:** Select the "reset" status (see Fig. 78).
4. **Calling the "Recipe" selection list:** Tap on the current recipe name (Fig. "Program generator"/2).
The recipe selection list will be displayed. Note: If the application technician has not given the recipes special names, then the system will give these recipes an automatically generated name that consists of the characters "Rec" and a consecutive number (e.g. "Rec 2").

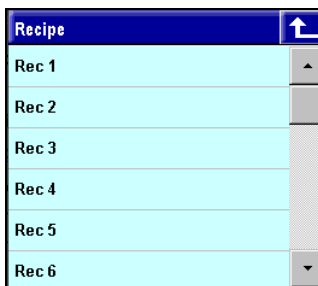

Fig. 80: Select recipe

5. **Selecting a recipe:** Tap on the desired recipe.

Directly changing programs



DANGER!

Program changes pose an injury hazard!

Faulty intervention in applications can result in an uncontrolled and/or unforeseeable operating sequence (as with any electronic controller system). Death, serious injury, or significant property damage can be the result.

Therefore:

- Prior to making any program change consider the effects of the change and ensure that appropriate measures have been taken.

If provided by the application developer you can directly intervene in the program execution on the main page. This affects the setpoint, the segment selection and the segment times.

Proceed as follows to select a value:

1. **Select value:** Click on the appropriate value to select it. The numerical value editor will start (see the following fig.).

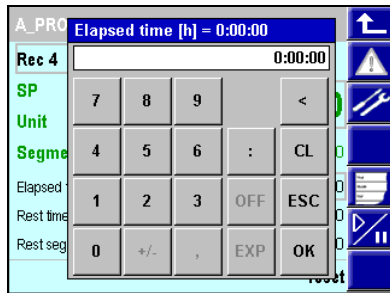

Fig. 81: Change program

2. **Enter new value:** Enter the new value and close the editor by clicking on "OK".

Change recipe



DANGER!

Recipe changes pose an injury hazard!

Faulty intervention in applications can result in an uncontrolled and/or unforeseeable operating sequence (as with any electronic controller system). Death, serious injury, or significant property damage can be the result.

Therefore:

- Prior to making any recipe change consider the effects of the change and ensure that appropriate measures have been taken.

Recipes are comprised of segments that contain value pairs (time/setpoint). If provided by the programmer you can change the time as well as the setpoint.

To do this, proceed as follows:

1. **Call the "Parameters" operating page:** Tap on the button "Call parameter page" (Fig. "Program generator"/12) to call the "Parameters" operating page.

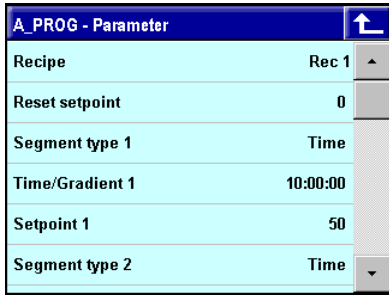

Fig. 82: Program generator ("Parameters" operating page)

- Select recipe:** Now you must specify which recipe you want to change. The currently selected recipe will be displayed on the first line (In the above fig.: "Rec 1"). Tap on this entry, if you *do not* want this recipe but rather want to edit a different recipe. Now you see a list of recipes (see Fig. below), Click on the desired recipe to select it.

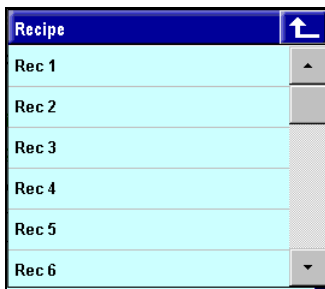

Fig. 83: Select recipe

- Change recipe:** Now you see the parameter dialog for the selected recipe. Tap on the value (time, setpoint) that will be changed and enter the new value. The appropriate editor will be displayed to edit the value (numerical value editor or binary number editor).

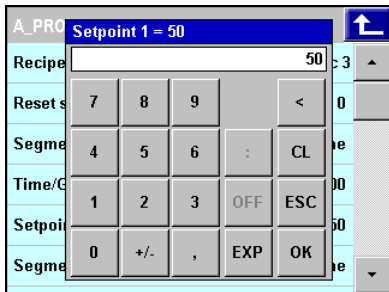

Fig. 84: Change recipe



NOTE!

Recipe changes during program execution only have an effect if they have been made in the current recipe or in a future recipe.

Start/restart recipe



NOTE!

The possibility of selecting a recipe in accordance with the following description depends on the application environment.

Proceed as follows to start the program:

- Call the "Commands" selection list:** Tap on the button "Supplemental commands" (Fig. "Program generator"/14).
- Select "run" status:** Select "run" status to start the program.

Pstate		↑
2:	run	
3:	reset	

Fig. 85: Select "run" status

If the program generator has been configured so that after execution of the recipe the recipe will stop (the message "end" (Fig. "Program generator"/7) will be displayed), then the recipe can be restarted manually. To do this the program generator must be set to the beginning with the command "Reset".

Proceed as follows to restart the recipe:

1. **Call the "Commands" selection list:** Tap on the button "Supplemental commands" (Fig. "Program generator"/14).
2. **Select "reset" status:** Select "reset" status (see Fig. 85).
3. **Call the "Commands" selection list:** Tap again on the field "Status program generator" to open the selection list again.
4. **Select "run" status:** Select "run" status to restart the program.

Stop program

Proceed as follows to stop a program:

1. **Call the "Commands" selection list:** Tap on the button "Supplemental commands" (Fig. "Program generator"/14).
2. **Select "stop" status:** Select the status "stop".

Pstate		↑
1:	stop	
3:	reset	

Fig. 86: Select "stop" status

Continue program

Proceed as follows to continue a program (if the recipe has been completely executed, you must use the process that is described above in the section "Restart recipe").

1. **Call the "Commands" selection list:** Tap on the button "Supplemental commands" (Fig. "Program generator"/14).
2. **Select "run" status:** Select the status "run".

Pstate		↑
2:	run	
3:	reset	

Fig. 87: Select "run" status

Starting/stopping a program with function key

Depending on the application configuration you can start or stop a program with the function key (Fig. "Program generator"/15).

Click on the function key to start or stop the program.

Working with multiple tracks

If at least one additional track is available then you can change the track by clicking on the button "▶▶" (Fig. "Program generator"/13).

Additional clicks take you to the available additional tracks. To return to the master track: Tap on the "▶▶" button until the master track is again displayed (the pages are arranged in a circular series).

I-5.7.10 Operating page D_PROG

The operating pages of the digital program generator ("D_PROG") provide information about program execution and permit intervention in the program.

Properties

- **Process value display:** The process value of the current track will be displayed.
- **Runtime display:** The remaining runtime for recipe and segment, as well as total runtime of the recipe are displayed.
- **Manual mode:** If provided by the application developer switch over between automatic mode and manual mode is possible.
- **Function switch:** Configurable button.
- **Change programs/recipes:** The user can intervene directly in the program execution and can also change recipes.

 **NOTE!**
Additional information on the program generator is available in the function block reference.

Overview

- 1 Title
- 2 Recipe name
- 3 Name - forced value
- 4 Forced value
- 5 Segment number
- 6 Net program time
- 7 Remaining program time
- 8 Remaining segment time
- 9 Button "Leave Operating Page"
- 10 Button "Alarm"
- 11 Button "Call parameter page"
- 12 Bit position
- 13 Button "Track change"
- 14 Button "Change operating status" (selection menu is displayed depending on the application)
- 15 Button "Function key" (the meaning of the button is specified in the configuration)
- 16 Button "Switch over automatic mode/manual mode"
- 17 Status line program generator (Operating states: "man", "end", "reset" and "stop")

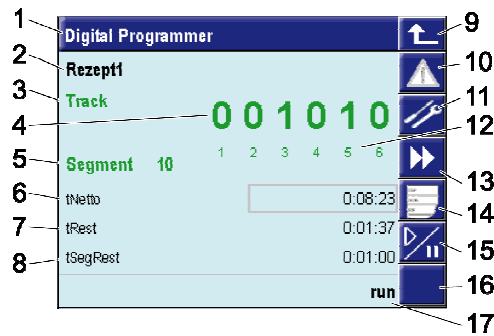

D_PROG - Parameter	
Recipe	Rec 1
Reset control bits	000000
Segment time 1	0:00:00
control bits 1	010100
Segment time 2	0:00:00
control bits 2	001100

Fig. 88: Program generator (overview and parameters)

Operation

Use the button "Call parameter page" (Fig. "Program generator"/11) to call the parameter page. Here the recipe name, the six control tracks, and the segment parameters of the currently active recipe are displayed.

Recipe selection

Tap on the "Recipe" button to display a different recipe.

**NOTE!**

This process is possible at anytime, as it does not cause switch over of the active recipe.

General operation**NOTE!**

Basic explanations for operating the program generator are available in the section "Operating page A_PROG".

I-6 Maintenance and cleaning



WARNING!

Danger of injury if personnel are not qualified to work on the device!

Improper handling of the device can cause serious injury and property damage.

Therefore:

- Only qualified personnel should perform maintenance work on the device.



DANGER!

Danger of injury due to unforeseeable system function sequences and movement sequences!

System components can be placed in movement during maintenance work, configuration work, or function checks, if they are not disconnected from the device.

Therefore:

If the device is taken out of service, if new or changed applications are loaded on the device, or if maintenance or a function check is performed, the following must be heeded:

- All system components must be disconnected from the device!
- All switched off system components must be safeguarded from being inadvertently switched on again!
- In general the effects of switching off the system must be taken into consideration and appropriate measures must be taken.



DANGER!

Danger of injury due to uncontrolled/unforeseeable operating sequences!

As with any electronic controller system, device failure can result in an uncontrolled and/or unforeseeable operating sequence. Death, serious injury, or significant property damage can be the result.

Therefore:

- Ensure that appropriate measures are in place every time the device is used.

I-6.1 Maintenance

I-6.1.1 Real-time clock

The KS 108 is equipped with a battery-buffered real-time clock; its charged status can be monitored.



NOTE!

The real-time clock can be checked using the PMA library XXXX block.

**CAUTION!**

Function restrictions for the real-time clock are possible if the wrong voltage is applied!

If the voltage of the real-time clock underranges 2.0V or exceeds 3.2V then the function of the real-time clock is endangered or the real-time clock can be damaged.

Therefore:

- Ensure that only the battery type specified below is used.
- Regularly check the voltage of the buffer battery.

I-6.1.1 Changing batteries

The installed battery must be replaced every 5 years, regardless of the charge status. This is the only maintenance task required.

**NOTE!**

Application data are lost when the battery is replaced. Therefore after replacing the battery you must reimport the application on the device.

The following charge states of the battery must be heeded:

Voltage	
3.2 V	Typical voltage for a new battery. Do not exceed this value!
3.0 V	Battery rated voltage
2.5 V	Battery replacement necessary
2.0 V	Battery must be replaced immediately to ensure the function of the real-time clock.

**DANGER!**

Explosion hazard!

Therefore:

- Do not throw new or discharged batteries into a fire, do not recharge them, and do not dismantle them.
- Only use type CR1620 (3V lithium battery) batteries!
- When inserting pay attention to correct polarity of the battery.

**NOTE!**

The battery voltage can be checked with a block of the PMA library. When developing applications verification of battery voltage must be integrated that warns the user of a drop in voltage in good time.

**CAUTION!**

The battery holder can be destroyed by bending!

The battery is held by a spring bracket. This spring bracket can be destroyed by lifting.

Therefore:

- When changing the battery never lift the spring bracket.

1. **Unplug the power cable:** Unplug the power cable from the device (see chapter: "Connecting the device").
2. **Removing batteries:** Use insulated tweezers to remove the battery.
3. **Slide the batteries into the device:** Slide the batteries into the battery compartment. In this process pay attention to the correct polarity of the batteries!
4. **Connecting the power supply cable to the device:** Reconnect the power cable to the device (see chapter: "Connecting the device").
5. **Load the application program:** Load the application program (see the section "Loading the application program" in the manual "II Development Environment"),

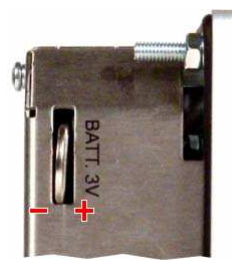

Fig. 89: Changing batteries

I-6.2 Cleaning



DANGER!

Danger of injury due to unforeseeable plant function sequences and movement sequences!

Unintentional or uncoordinated contact of touch sensitive displays can cause malfunctions or unforeseeable plant reactions.

Therefore:

- Switch off the device, the plant, or all plant components, prior to cleaning the device!
- All switched off plant components must be safeguarded from being inadvertently switched on again!
- In general the effects of switching off the plant must be taken into consideration and appropriate measures must be taken.



CAUTION!

Device damage due to improper cleaning!

The use of improper cleaning agents or cleaning improperly can cause significant device damage. The display in particular is extremely sensitive.

Therefore:

- Never use a high-pressure cleaner or steam jet to clean the device.
- Do not use aggressive cleaning agents, solvents, cleanser, or hard objects to clean the device.
- Always use extremely light contact pressure to clean the front panel and the display.

Procedure

Clean the front panel of the device with a lint-free, soft, slightly damp cloth.

I-6.2.1 Cleaning heavy fouling



NOTE!

If the device is heavily fouled, ethyl alcohol or isopropyl alcohol can be used to clean the screen in accordance with DIN 42115 Part 2.



CAUTION!

Danger of non-intended program reactions due to cleaning!

The screen of the *KS 108 easy* is touch sensitive. The cleaning process can trigger program reactions.

Therefore:

- Always have the menu "General Data" available in your application: Call the operating page "General Data/Clean Screen" before cleaning the screen.
- Prior to cleaning always call a screen page that cannot effect any undesired program reactions.

I-6.3 After maintenance

After maintenance work, before placing the device in service, you must ensure that proper operation is possible. Ensure that:

- No foreign objects are in the device.
- All connections have been established correctly.
- The enclosure cover is mounted.
- The PE is correctly connected.

I-7 Troubleshooting

**WARNING!**

Danger of injury if personnel are not qualified to work on the device!

Improper handling of the device can cause serious injury and property damage.

Therefore:

- Only qualified personnel should perform maintenance work on the device.

**DANGER!**

Danger of injury due to unforeseeable system function sequences and movement sequences!

System components can be placed in movement during maintenance work, configuration work, or function checks, if they are not disconnected from the device.

Therefore:

If the device is taken out of service, if new or changed applications are loaded on the device, or if maintenance or a function check is performed, the following must be heeded:

- All system components must be disconnected from the device!
- All switched off system components must be safeguarded from being inadvertently switched on again!
- In general the effects of switching off the system must be taken into consideration and appropriate measures must be taken.

**DANGER!**

Danger of injury due to uncontrolled/unforeseeable operating sequences!

As with any electronic controller system, device failure can result in an uncontrolled and/or unforeseeable operating sequence. Death, serious injury, or significant property damage can be the result.

Therefore:

- Ensure that appropriate measures are in place every time the device is used.

I-7.1 Fault table

Fault	Presumable cause	Recommended measure
Device does not start	Power supply disrupted	<ul style="list-style-type: none"> ■ Check whether the power supply cable is connected, and whether the power supply is working. ■ Check the pin assignment of the power supply for correct polarity. ■ Check whether the supply voltage corresponds to the device's connection values.
Device does not boot completely	Device is defective	<ul style="list-style-type: none"> ■ First try to reboot the device. ■ If that does not help: Contact PMA

If the measures described above are not successful, please contact PMA.

II Index

A	
A_PROG	80, 86
Alarm history	49f.
Alarm page	36, 48f.
Application development	15, 47
B	
Bargraph	36, 53, 62
Batteries	15
Battery	88
Block diagram	23
C	
CAN interface	19, 23, 25
Cascade	66f.
Cascade control	66
Cleaning	90
Commissioning	31
Communication protocol	18
Condensation of water	9
Control parameter	63, 76
Controller	62, 66-69, 74
Copyright	8
Customer service	6
D	
Data logger	54f.
Device failure	14
Dimensions	20
Display	20, 37, 51, 53, 58, 62f., 80
Disposal	9
E	
EMC	21
Environmental protection	16
Ethernet	18f., 21, 23f., 31, 35, 44, 46
Explanation of symbols	7
Explosion protection	14
F	
Function	47, 80, 85, 88
I	
installation	6, 12, 27, 31
Installation	27
Instructed person	13
Instruction	13
Intended use	16
Interfaces	18, 23, 31
IP address	42
L	
Limitation of liability	8
LINUX	22
M	
Main menu	38
maintenance	6, 12, 14, 16, 32, 87f., 91f.
Manual	62, 80, 85
Manual mode	62, 80, 85
Mounting	20, 27-29
Mounting cutout	27f.
O	
Operating personnel	13
Ores	63, 65, 73, 78
Owner	12
P	
Power supply	24, 30, 93
Program memory	20
Q	
Qualified electrician	13
R	
Recipe	80-83, 85f.
Recipe name	80, 85
Recipes	82
RS 232	19, 23, 25
RS 485	19, 22f., 25
S	
Safety	11, 14, 21
SD card	18-20, 22, 34, 49f., 54
Segment	80, 85
Self-optimization	62-65, 69f., 72-75, 77
Specialized personnel	31
Standard	18
step controller	68, 73f.
Storage	9
T	
Technical data	20

Touchscreen	20	User display	36, 51
Transport	9	V	
Trend	36, 57-59, 60	V_ALARM	36, 48
Troubleshooting	92	V_BAR	36, 53
Type plate	22	V_DISPLAY	36, 51
U		V_LOGGING	36, 54f.
USB	18-21, 24f., 31-33, 48-50, 54-56	V_TREND	36, 57